



UNIVERSIDAD DE BUENOS AIRES  
Facultad de Ciencias Exactas y Naturales  
Departamento de Matemática

## **Caracterizaciones Estructurales de Grafos de Intersección**

Tesis presentada para optar al título de Doctor de la Universidad de Buenos Aires en el área  
Ciencias Matemáticas

**Luciano Norberto Grippo**

Director de tesis: Dr. Guillermo Alfredo Durán  
Director Asistente: Dra. Flavia Bonomo  
Consejero de estudios: Dra. Claudia Lederman

Lugar de trabajo: Departamento de Computación, FCEyN, UBA.

Buenos Aires, 2011



## Caracterizaciones estructurales de grafos de intersección

En esta tesis estudiamos caracterizaciones estructurales para grafos arco-circulares, grafos círculo, grafos *probe* de intervalos, grafos *probe* de intervalos unitarios, grafos *probe* de bloques y grafos *probe* co-bipartitos. Un grafo es arco circular (círculo) si es el grafo de intersección de una familia de arcos (cuerdas) en una circunferencia. Dada una familia hereditaria de grafos  $\mathcal{G}$ , un grafo es *probe*  $\mathcal{G}$  si sus vértices pueden partitionarse en dos conjuntos: un conjunto de vértices *probe* y un conjunto de vértices *nonprobe*, de forma tal que el conjunto de vértices *nonprobe* es un conjunto independiente y es posible obtener un grafo en la clase  $\mathcal{G}$  agregando aristas entre ellos. Los grafos *probe*  $\mathcal{G}$  forman una superclase de la familia  $\mathcal{G}$ . Por lo tanto, los grafos *probe* de intervalos y los grafos *probe* de intervalos unitarios generalizan la clase de los grafos de intervalos y los grafos de intervalos unitarios respectivamente.

Caracterizamos parcialmente a los grafos arco-circulares, grafos círculo, grafos *probe* de intervalos y *probe* de intervalo unitario mediante subgrafos prohibidos dentro de ciertas familias hereditarias de grafos. Finalmente, es presentada una caracterización de los grafos *probe* co-bipartitos que lleva a un algoritmo de reconocimiento de tiempo polinomial para dicha clase y los grafos *probe* de bloques son caracterizados mediante una lista de subgrafos prohibidos.

**Palabras clave:** grafos arco circulares, grafos círculo, subgrafos inducidos prohibidos, grafos *probe* de bloques, grafos *probe* co-bipartitos, grafos *probe* de intervalos, grafos *probe* de intervalos unitarios.

---



## Structural characterizations of intersection graphs

In this Thesis we study structural characterizations for six classes of graphs, namely circular-arc graphs, circle graphs, probe interval graphs, probe unit interval graphs, probe co-bipartite graphs, and probe block graphs. A circular-arc graph (circle graph) is the intersection graph of a family of arcs (chords) on a circle. Let  $\mathcal{G}$  be a hereditary class of graphs. A graph is probe  $\mathcal{G}$  if its vertices can be partitioned into two sets: a set of probe vertices and a set of nonprobe vertices, so that the set of nonprobe vertices is a stable set and it is possible to obtain a graph belonging to the class  $\mathcal{G}$  by adding edges with both endpoints in the set of nonprobe vertices. Probe  $\mathcal{G}$  graphs form a superclass of the class  $\mathcal{G}$ . Hence, probe interval graphs and probe unit interval graphs are extensions of the classes of interval graphs and unit interval graphs, respectively.

We partially characterize circular-arc graphs, circle graphs, probe interval graphs and probe unit interval graphs by forbidden induced subgraphs within certain hereditary families of graphs. Finally, a structural characterization for probe co-bipartite graphs that leads to a polynomial-time recognition algorithm and a complete characterization of probe block graphs by a list of forbidden induced subgraphs are presented.

**Keywords:** circular-arc graphs, circle graphs, forbidden induced subgraph, probe block graphs, probe co-bipartite graphs, probe interval graphs, probe unit interval graphs.

---



# Introducción

Los grafos arco-circulares son los grafos de intersección de una familia  $S$  de arcos en una circunferencia, al conjunto  $S$  se lo llama modelo arco-circular. Los primeros trabajos sobre esta clase de grafos fueron publicados por Hadwiger y otros en 1964 [HDK64] y por Klee [Kle69] en 1969 respectivamente. Sin embargo, el primero en trabajar en el problema de caracterizar por subgrafos prohibidos esta familia de grafos fue A. Tucker en su tesis doctoral en 1969 [Tuc60]. Fue él mismo quien introdujo y consiguió caracterizar por subgrafos prohibidos dos subclases de grafos arco-circulares: grafos arco-circulares unitarios y grafos arco-circulares propios. La primera subclase consiste en aquellos grafos arco-circulares que poseen un modelo arco-circular con todos sus arcos de la misma longitud y la segunda subclase son los grafos arco-circulares con un modelo donde ningún arco está contenido en otro.

Caracterizar la clase completa de grafos arco-circulares por subgrafos prohibidos es un problema abierto desde hace mucho tiempo. Sin embargo varios autores han presentado algunos avances en esta dirección. Trotter y Moore dieron una caracterización por subgrafos prohibidos inducidos dentro de la clase de grafos co-bipartitos [TM76]. J. Bang-Jensen y P. Hell presentaron un teorema estructural para grafos arco-circulares propios dentro de la clase de grafos cordales [BH94], del cual se desprende la caracterización por subgrafos inducidos prohibidos para los grafos arco-circulares propios restringidos a la clase de los grafos cordales.

Los grafos arco-circulares son una generalización de la familia de grafos de intersección de intervalos en la recta real, llamados grafos de intervalos. Los grafos de intervalos fueron caracterizados por Boland y Lekkerkerker en 1962 [LB62]. La lista completa de subgrafos inducidos prohibidos que caracteriza los grafos de intervalos fue hallada exitosamente via una caracterización por medio de triplas asteroidales presentada por los mismos autores. Todo conjunto de intervalos en la recta real satisface la propiedad de Helly; es decir, cualquier conjunto de intervalos mutuamente intersecantes en la recta real tiene un punto en común. Por lo tanto una subclase de grafos arco-circulares que generaliza a los grafos de intervalos de forma natural son los grafos arco-circulares Helly; es decir, aquellos grafos arco-circulares que tienen un modelo que satisface la propiedad de Helly. Lin y Szwarcfiter presentaron una caracterización para esta clase mediante estructuras prohibidas dentro de la clase de los grafos arco-circulares [LS06a]. Dicha caracterización lleva a un algoritmo de reconocimiento lineal para la clase de los grafos arco-circulares Helly. Lin y otros introdujeron y caracterizaron

---

la clase de los grafos arco-circulares propios Helly [LSS07], aquellos grafos que tienen un modelo arco-circular que es simultáneamente propio y Helly.

P. Hell probó que la familia de los bigrafos de intervalos son exactamente aquellos grafos arco-circulares con número de cubrimiento por clique dos y poseen un modelo arco-circular sin dos arcos que cubran la circunferencia completa. Los grafos arco-circulares que satisfacen dicha condición son conocidos en la literatura como grafos arco-circulares normales. Esta terminología fue introducida en [LS06b]. Generalizando los grafos arco-circulares, L. Alcón y otros introdujeron la clase de los grafos bucle.

A pesar de que muchos investigadores han tratado de encontrar la lista de subgrafos prohibidos que caracterice la clase de los grafos arco-circulares, el problema aún permanece abierto. En esta tesis presentamos algunos pasos en esta dirección, aportando caracterizaciones de grafos arco-circulares por subgrafos inducidos prohibidos minimales cuando el grafo pertenece a alguna de las siguientes clases: grafos sin  $P_4$ , grafos sin  $paw$ , grafos cordales sin  $claw$  y grafos sin diamante. Además, como los grafos arco-circulares que pertenecen a estas clases tienen un modelo arco-circular normal, estos resultados implican que los subgrafos inducidos prohibidos para la clase de los grafos arco-circulares normales necesariamente contienen un diamante inducido, un  $P_4$  inducido, un  $paw$  inducido, y o bien un  $claw$  o un agujero como subgrafo inducido. También introducimos y caracterizamos la clase de los grafos semicirculares, grafos arco-circulares que tienen un modelo arco-circular donde todos sus arcos son semicircunferencias. Cabe destacar que todas estas clases fueron estudiadas a lo largo del camino hacia la prueba del Teorema Fuerte de los Grafos Perfectos [Con89, Ola88, PR76, Sei74, Tuc87].

Un grafo se dice círculo si es el grafo de intersección de un conjunto de cuerdas en una circunferencia, a tal conjunto se lo llama modelo de círculo. Los grafos círculo fueron introducidos por Even e Itai en [EI71] para resolver un problema de ordenamiento con el mínimo número de pilas en paralelo sin la restricción de cargar antes que la descarga sea completada. Ellos también probaron que este problema se puede traducir en el problema de hallar el número cromático de un grafo círculo. Desafortunadamente este problema resulta ser NP-completo [GJMP80].

Naji caracterizó los grafos círculo en términos de la solución de un sistema lineal de ecuaciones que lleva a un algoritmo de reconocimiento  $O(n^7)$  para esta clase [Naj85]. El complemento de un grafo  $G$  con respecto a un vértice  $u \in V(G)$  es el grafo  $G * u$  que se obtiene a partir de  $G$  reemplazando el subgrafo inducido  $G[N_G(u)]$  por su complemento. Este tipo de operación se denomina complementación local. Se dice que dos grafos  $G$  y  $H$  son localmente equivalentes si y solo si  $G$  se obtiene a partir de  $H$  mediante una sucesión de complementaciones locales. Bouchet probó que los grafos círculo son cerrados bajo complementación local, también probó

---



que un grafo es círculo si y solo si todo grafo localmente equivalente no contiene tres determinados grafos como subgrafo inducido [Bou94]. Geelen y Oum [GO09] dieron una nueva caracterización de grafos círculo en términos de la operación de pivoteo. El resultado de pivotear un grafo  $G$  con respecto a una arista  $uv$  es la grafo  $G \times uv = G * u * v * u$  (donde  $*$  representa a la complementación local). Un grafo  $G'$  es equivalente por pivoteo a  $G$  si  $G'$  se obtiene a partir de  $G$  mediante una secuencia de operaciones de pivoteo. Ellos probaron, con la ayuda de una computadora, que  $G$  es un grafo círculo si y solo si cada grafo equivalente por pivoteo a  $G$  no contiene ninguno de 15 grafos determinados como subgrafo inducido.

Un grafo círculo que posee un modelo tal que todas sus cuerdas tienen la misma longitud se llama grafo círculo unitario. La clase de grafos arco-circulares propios está propiamente contenida en la clase de los grafos círculo. Más aún, la clase de los grafos arco-circulares unitarios coincide con la clase de los grafos círculo unitario.

Decimos que  $G$  tiene una descomposición *split* si existen dos grafos  $G_1$  y  $G_2$  con  $|V(G_i)| \geq 3$ ,  $i = 1, 2$ , tal que  $G = G_1 * G_2$  con respecto a algunos vértices destacados (ver Ch. 3). Si esto sucede llamamos a  $G_1$  y  $G_2$  factores de la descomposición *split*. A aquellos grafos que no poseen una descomposición *split* se los llama *primos*. El concepto de descomposición *split* es debido a Cunningham [Cun82]. Los grafos círculo resultaron ser cerrados por descomposición *split* [Bou87] y en 1994 Spinrad presentó un algoritmo de tiempo cuadrático que se aprovecha de esta peculiaridad.

Los grafos círculo son una superclase de los grafos de permutación. De hecho, los grafos de permutación pueden ser definidos como aquellos grafos círculo tales que una cuerda que interseque todas las cuerdas del modelo puede ser agregada. Por otro lado los grafos de permutación son aquellos grafos de comparabilidad cuyo grafo complemento es también de comparabilidad. Como los grafos de comparabilidad han sido caracterizados por subgrafos prohibidos inducidos en [Gal67], tal caracterización implica una caracterización por subgrafos inducidos prohibidos para la clase de los grafos de permutación.

Los grafos de círculo Helly son aquellos grafos de círculo que tienen un modelo cuyas cuerdas satisfacen la propiedad de Helly; es decir, todo conjunto de cuerdas que se intersecan dos a dos tienen un punto en común. Esta familia de grafos fue introducida por Durán en [Dur00]. Él también conjeturó que un grafo círculo es círculo Helly si y solo si no contiene un diamante como subgrafo inducido. Recientemente, ésta conjetura fue probada. Sin embargo, los grafos círculo Helly aún no han sido caracterizados por subgrafos prohibidos.

En esta tesis presentamos algunas caracterizaciones parciales por subgrafos prohibidos inducidos. Caracterizamos los grafos círculo dentro de los

grafos domino lineales usando la descomposición *split*. Consecuentemente, caracterizamos los grafos círculo Helly dentro de la clase de los grafos sin *claw*. Caracterizaciones por subgrafos inducidos prohibidos dentro de dos superclases de cografos, *tree-cographs* y  $P_4$ -tidy, son presentadas como una aplicación de la caracterización de Gallai para grafos de comparabilidad. Finalmente introducimos y caracterizamos la clase de los grafos círculo Helly unitarios, aquellos grafos círculo que tienen un modelo que es simultáneamente Helly y unitario.

Sea  $\mathcal{G}$  una clase hereditaria de grafos. Un grafo se dice *probe*  $\mathcal{G}$  si sus vértices pueden ser particionados en dos conjuntos: un conjunto de vértices *probe* y un conjunto de vértices *nonprobe*, de forma tal que el conjunto de vértices *nonprobe* es un conjunto independiente y se puede obtener un grafo perteneciente a la clase  $\mathcal{G}$  agregando aristas con ambos extremos en el conjunto de vértices *nonprobe*.

En 1994 Zhag introdujo los grafos *probe* de intervalos como una herramienta de investigación en el marco del proyecto del genoma humano, [ZSF<sup>+</sup>94]. Desde entonces, los grafos *probe*  $\mathcal{G}$  han sido estudiados para diferentes familias hereditarias de grafos  $\mathcal{G}$ . Sheng caracterizó por subgrafos inducidos prohibidos aquellos árboles que son *probe* de intervalo [She99]. Brown y otros presentaron una caracterización por subgrafos inducidos prohibidos dentro de la clase de los árboles [BLS09]. Pržulj y Corneil estudiaron los subgrafos prohibidos para grafos *probe* de intervalos dentro de la clase de los *2-tree* [PC05]. Brown y Lundgren probaron que los grafos *probe* de intervalos bipartitos son equivalentes a el complemento de una clase de grafos arco-circulares con número de cubrimiento clique dos [BL06]. En [BBd09], Bayer y otros caracterizaron dos subclases de los grafos *probe* de intervalos, los grafos *probe threshold* y los grafos *probe* trivialmente perfectos, en términos de ciertas fórmulas 2-SAT. En el mismo artículo ellos presentan una caracterización por subgrafos prohibidos para los grafos *probe threshold*.

Las clases de los grafos *probe*  $\mathcal{G}$ , con  $\mathcal{G}$  diferentes de los grafos de intervalos y de intervalos unitarios, han sido estudiadas para importantes clases de grafos como por ejemplo: grafos cordales [GL04, CGLS10], grafos de permutación [CCK<sup>+</sup>09] y grafos *split* [LdR07] entre otros.

Con el objetivo de estudiar el comportamiento del operados *join* para los grafos *probe* de intervalos e intervalo unitario introducimos el concepto de clases hereditarias de grafos con un compañero. También presentamos la lista completa de todos los subgrafos inducidos prohibidos cuyo complemento es desconexo para la clase de los grafos *probe* de intervalos. A pesar de no conseguir hacer lo mismo para la clase de los grafos *probe* de intervalos unitarios, presentamos la lista de subgrafos inducidos prohibidos dentro de la clases de *tree-cographs* y  $P_4$ -tidy. Damos una caracterización en términos de subgrafos inducidos prohibidos para aquellos grafos co-bipartitos

---

que son *probe* de intervalos, esta caracterización implica que los grafos co-bipartitos *probe* de intervalos y los grafos co-bipartitos *probe* de intervalos unitarios son la misma clase. Los grafos *probe* de intervalos y de intervalos unitarios son caracterizados por subgrafos inducidos prohibidos dentro de la clase de los *tree-cographs*, generalizando las caracterizaciones presentadas en [She99] y [BLS09], respectivamente. Finalmente, caracterizamos por subgrafos prohibidos inducidos los grafos *probe* de intervalos y de intervalos unitarios dentro de la clase de los grafos  $P_4$ -*tidy*. También estudiamos la clase de grafos *probe* de grafos co-bipartitos y grafos de bloques. Los grafos *probe* de bloques son una subclase de los grafos *probe* cordales estudiados en [GL04, CGLS10]. Los grafos *probe* cordales no han sido aún caracterizados por subgrafos prohibidos inducidos. En esta tesis presentamos una caracterización para grafos *probe* de grafos de bloques por subgrafos prohibidos inducidos y probamos que la clase de los grafos *probe* de grafos de bloques es la intersección entre las clases de grafos cordales y *probe* de grafos sin diamante. También presentamos una caracterización estructural para la clase de los grafos *probe* co-bipartitos que lleva a un simple algoritmo de reconocimiento de tiempo polinomial para esta clase.

Esta tesis está organizada como sigue. En el Capítulo 1 damos algunas definiciones y un breve resumen sobre las clases de grafos estudiadas en esta tesis. El Capítulo 2 está dedicado a los grafos arco-circulares. En el Capítulo 3 presentamos caracterizaciones para grafos círculo. Los grafos *probe* de intervalos y los grafos *probe* de intervalos unitarios son estudiados en el Capítulo 4. En el Capítulo 5 presentamos caracterizaciones estructurales para los grafos *probe* de grafos de bloques y *probe* de grafos co-bipartitos.

---



# Contents

<b>Introduction</b>	<b>xiii</b>
<b>1 Preliminaries</b>	<b>1</b>
1.1 Definitions and notation . . . . .	1
1.2 Overview on some classes of graphs . . . . .	3
1.2.1 Domino graphs . . . . .	3
1.2.2 Intersection graphs . . . . .	4
1.2.3 Cographs and its superclasses . . . . .	8
<b>2 Circular-arc graphs</b>	<b>11</b>
2.1 Introduction . . . . .	11
2.2 Preliminaries . . . . .	12
2.2.1 Definitions . . . . .	12
2.2.2 Previous results . . . . .	12
2.3 Partial characterizations . . . . .	15
2.3.1 Cographs . . . . .	15
2.3.2 Paw-free graphs . . . . .	18
2.3.3 Claw-free chordal graphs . . . . .	20
2.3.4 Diamond-free graphs . . . . .	23
2.4 Summary and further results . . . . .	26
<b>3 Circle graphs</b>	<b>29</b>
3.1 Introduction . . . . .	29
3.2 Linear domino graphs . . . . .	32
3.3 Superclasses of cographs . . . . .	37
3.3.1 $P_4$ -tidy graphs . . . . .	37
3.3.2 Tree cographs . . . . .	38
3.4 Unit Helly circle graphs . . . . .	38
<b>4 Probe interval graphs</b>	<b>41</b>
4.1 Preliminaries . . . . .	41
4.2 Co-bipartite graphs . . . . .	43
4.3 Probe interval graphs . . . . .	46
4.4 Graphs classes with a companion . . . . .	50

4.5	Partial characterization of probe $\{3K_1, C_4, C_5\}$ -free graphs . .	53
4.6	Partial characterizations of probe unit interval graphs . . . .	56
<b>5</b>	<b>Probe co-bipartite and probe block graphs</b>	<b>59</b>
5.1	Probe co-bipartite graphs . . . . .	59
5.2	Probe block graphs . . . . .	60
5.2.1	Probe diamond-free graphs . . . . .	60
5.2.2	Probe block graphs . . . . .	68
<b>6</b>	<b>Conclusions and future work</b>	<b>71</b>
	<b>Bibliography</b>	<b>73</b>

---

# Introduction

Circular-arc graphs are the intersection graphs of a set  $\mathcal{S}$  of arcs on a circle, such a set  $\mathcal{S}$  is called a circular-arc model. The first works about this class of graphs were published by Hadwiger et al. in 1964 [HDK64] and by Klee [Kle69] in 1969. Nevertheless, the first researcher who dealt with the problem of characterizing by forbidden subgraphs this family of graphs was A. Tucker in his Ph.D. Thesis in 1969 [Tuc60]. He introduced and managed to characterize by forbidden induced subgraphs two subclasses of circular arc-graphs: unit circular-arc graphs and proper circular-arc graphs. The first subclass consists of those circular-arc graphs having a circular-arc model with all its arcs having the same length and the second one consists of those circular-arc graphs having a circular-arc model without any arc contained in another.

Characterizing by forbidden induced subgraphs the whole class of circular-arc graphs is a long standing open problem. Nevertheless, several authors have presented some advances in this way. Trotter and Moore gave a characterization by forbidden induced subgraphs within the class of co-bipartite graphs [TM76]. J. Bang-Jensen and P. Hell presented a structural theorem for proper circular-arc graphs within the class of chordal graphs [BH94], that implies the characterization by forbidden induced subgraphs for proper circular-arc graphs restricted to the class of chordal graphs.

Circular-arc graphs are a generalization of the family of the intersection graphs of intervals in the real line, called interval graphs. Interval graphs were characterized by Boland and Lekkerkerker in 1962 [LB62]. The whole list of forbidden induced subgraphs that characterizes interval graphs was successfully found via a characterization by means of asteroidal triples presented by the same authors. Any set of interval in the real line satisfies the Helly property; i.e., any set of pairwise intersecting intervals in the real line have a common point. Consequently, a subclass of circular-arc graphs that naturally generalizes interval graphs are the Helly circular-arc graphs; i.e., those circular-arc graphs having an intersection model of arcs such that any subset of pairwise intersecting arcs has a common point. Lin and Szwarcfiter presented a characterization by forbidden structures for this class within the class of circular-arc graphs [LS06a]. Such a characterization

yields a linear-time recognition algorithm for the class of Helly circular-arc graphs. Lin et al. introduced and characterized the class of proper Helly circular-arc graphs [LSS07], those graphs having a circular-arc model which is simultaneously proper and Helly.

A circular-arc graph having a circular-arc model without two arcs covering the whole circle is called normal circular-arc graph. This terminology was introduced in [LS06b]. P. Hell proved that interval bigraphs are exactly those circular-arc graphs with clique covering number two and having a normal circular-arc model [HH04]. Generalizing circular-arc graphs, L. Alc3n et al. introduced the class of loop graphs [ACH<sup>+</sup>07].

In spite of the fact that many researchers have been trying to find the list of forbidden subgraphs that characterizes the class of circular-arc graph, the problem still remains open. In this thesis we present some steps in this direction by providing characterizations of circular-arc graphs by minimal forbidden induced subgraphs, when the graph belongs to any of the following four different classes:  $P_4$ -free graphs, paw-free graphs, claw-free chordal graphs and diamond-free graphs. In addition, since circular-arc graphs belonging to these classes have a normal circular-arc model, these results imply that forbidden induced subgraphs for the class of normal circular-arc graphs necessarily contain a diamond, an induced  $P_4$ , an induced paw and either a claw or a hole as induced subgraph. We also introduce and characterize the class of semicircular graphs, circular-arc graphs having a circular-arc model where its arcs are semicircles. It is worth pointing out that all of these classes were studied along the way towards the proof of the Strong Perfect Graph Theorem [Con89, Ola88, PR76, Sei74, Tuc87]. The aforementioned results have been published in [BDGS09].

A graph is defined to be circle if it is the intersection graph of a set  $C$  of chords on a circle, such a set is called a circle model. Circle graphs were introduced by Even and Itai in [EI71] to solve an ordering problem with the minimum number of parallel stacks without the restriction of loading before unloading is completed, proving that the problem can be translated into the problem of finding the chromatic number of a circle graph. Unfortunately, this problem turns out to be NP-complete [GJMP80].

Naji characterized circle graphs in terms of the solvability of a system of linear equations, yielding a  $O(n^7)$  recognition algorithm for this class [Naj85]. The local complement of a graph  $G$  with respect to a vertex  $u \in V(G)$  is the graph  $G * u$  that arises from  $G$  by replacing the induced subgraph  $G[N_G(u)]$  by its complement. Two graphs  $G$  and  $H$  are locally equivalent if and only if  $G$  arises from  $H$  by a finite sequence of local complementations. Bouchet proved that circle graphs are closed under local complementation, as well as that a graph is circle if and only if every locally equivalent graph contains no three prescribed graphs [Bou94]. Inspired in



this result, Geelen and Oum [GO09] gave a new characterization of circle graphs in terms of pivoting. The result of pivoting a graph  $G$  with respect to an edge  $uv$  is the graph  $G \times uv = G * u * v * u$  (where  $*$  stands for local complementation). A graph  $G'$  is *pivot-equivalent* to  $G$  if  $G'$  arises from  $G$  by a sequence of pivoting operations. They proved, with the aid of a computer, that  $G$  is a circle graph if and only if each graph that is pivot-equivalent to  $G$  contains none of 15 prescribed induced subgraphs.

A circle graph with a circle model having all its chords of the same length is called a unit circle graph. It is well-known that the class of proper circular-arc graphs is properly contained in the class of circle graphs. Furthermore, the class of unit circular-arc graphs and the class of unit circle graphs are the same [Dur00].

We say that  $G$  has a split decomposition if there exist two graphs  $G_1$  and  $G_2$  with  $|V(G_i)| \geq 3$ ,  $i = 1, 2$ , such that  $G = G_1 * G_2$  with respect to some pair of marker vertices (Ch. 3 of this thesis). If so,  $G_1$  and  $G_2$  are called the factors of the split decomposition. Those graphs that do not have a split decomposition are called *prime graphs*. The concept of split decomposition is due to Cunningham [Cun82]. Circle graphs turned out to be closed under this decomposition [Bou87] and in 1994 Spinrad presented a quadratic-time recognizing algorithm for circle graphs that profits from this peculiarity [Spi94].

Circle graphs are a superclass of permutation graphs. Indeed, permutation graphs can be defined as those circle graphs having a circle model such that a chord can be added in such a way that this chord meets all the chords belonging to the circle model. On the other hand, permutation graphs are those comparability graphs whose complement graph is also a comparability graph. Since comparability graphs have been characterized by forbidden induced subgraphs [Gal67], such a characterizations implies a forbidden induced subgraphs characterization for the class of permutation graphs.

Helly circle graphs are those graphs having a circle model whose chords satisfy the Helly property; i.e, every set of pairwise adjacent chords have a common point. This family of graphs was introduced by Durán [Dur00]. He also conjectured that a circle graph is Helly circle if and only if it does not contain a diamond as induced subgraph. Recently, this conjecture was positively settled [DGR10]. Nevertheless, Helly circle graphs have not been characterized by forbidden induced subgraphs yet.

In this thesis we present some partial characterizations by forbidden induced subgraphs. We characterize circle graphs among linear domino graphs by profiting from split decomposition. Consequently, we characterize Helly circle graphs within the class of claw-free graphs. Characterizations by forbidden induced subgraphs within two superclasses of cographs,

tree-cographs and  $P_4$ -tidy graphs, are presented as an application of the characterization of Gallai for comparability graphs. Finally, we introduce and characterize the class of unit Helly circle graphs, circle graphs having a circle model which is simultaneously Helly and unit. This results were published in [BDGS].

Let  $\mathcal{G}$  be a hereditary class of graphs. A graph is defined to be probe  $\mathcal{G}$  if its vertex set can be partitioned into two sets: a set of probe vertices and a set of nonprobe vertices, so that the set of nonprobe vertices is a stable set and it can be obtained a graph belonging to  $\mathcal{G}$  by adding edges with both endpoints in the set of nonprobe vertices.

In 1994 Zhag introduced probe interval graphs as a research tool in the frame of the genome projet, [ZSF<sup>+</sup>94]. Since then, probe  $\mathcal{G}$  graphs have been studied for different hereditary families of graphs  $\mathcal{G}$ . Sheng characterized by forbidden induced subgraphs those trees which are probe interval [She99]. Brown et al. presented a characterization by forbidden induced subgraphs of probe unit interval graphs within the class of trees [BLS09]. Pržulj and Corneil studied the forbidden subgraphs for probe interval graphs among the class of 2-tree graphs [PC05]. Brown and Lundgren proved that bipartite probe interval graphs are equivalent to a the complement of a class of circular-arc graphs whose clique number is two [BL06]. In [BBd09], Bayer et al. characterize two subclasses of probe interval graphs, probe threshold and probe trivially perfect graphs, in terms of certain 2-SAT formulas . In the same article they present a characterization by forbidden subgraphs for probe threshold graphs. Classes of probe  $\mathcal{G}$  graphs, with  $\mathcal{G}$  different from interval and unit interval graphs, have been also studied for many important classes of graphs; e.g., chordal graphs [GL04, CGLS10], permutation graphs [CCK<sup>+</sup>09] and split graphs [LdR07], among others.

In order to study the behavior of the join operation for probe interval and probe unit interval graphs, we introduce the concept of hereditary class of graphs with a companion. We also present the whole list of all forbidden induced subgraphs whose complement is disconnected for the class of probe interval graphs. In spite of we cannot manage to do so for the class of probe unit interval graphs, we present the list of forbidden subgraphs, whose complement is disconnected, for probe unit interval graphs, within the classes of tree-cographs and  $P_4$ -tidy graphs. We give a characterization in terms of forbidden induced subgraphs for those co-bipartite graphs that are probe interval, this characterization implies that co-bipartite probe interval graphs and co-bipartite probe unit interval graphs are the same class of graphs. In addition, probe interval graphs and probe unit interval graphs are characterized by forbidden subgraphs within the class of tree-cographs, generalizing the characterizations presented in [She99] and [BLS09], respectively. This results will be published in [DGS]. Finally, we characterize

by forbidden induced subgraphs probe interval graphs and probe unit interval graphs within  $P_4$ -tidy graphs. We also study the classes of probe co-bipartite graphs and block graphs, presenting a structural characterization for probe co-bipartite graphs that leads to a polynomial-time recognizing algorithm for this class. Probe block graphs are a subclass of probe chordal graphs, studied in [GL04, CGLS10]. Probe chordal graphs have not been characterized by forbidden subgraphs yet. In this Thesis we present a characterization for probe block graphs by forbidden induced subgraphs and we prove that the class of probe block graphs is the intersection between the classes of chordal graphs and probe diamond-free graphs [BDd<sup>+</sup>].

This Thesis is organized as follows. In Chapter 1 we give some definitions and a brief overview on the classes we studied throughout this thesis. Chapter 2 is devoted to partial characterizations for circular-arc graphs. In Chapter 3 we present partial characterizations for circle graphs. Partial characterizations for probe interval graphs and probe unit interval graphs are studied in Chapter 4. Finally, in Chapter 5 we present structural characterization for probe co-bipartite graphs and probe block graphs.

---



# Chapter 1

## Preliminaries

### 1.1 Definitions and notation

A *graph*  $G$  is an ordered pair  $(V(G), E(G))$  consisting of a set  $V(G)$  called *vertices* and a set  $E(G)$  consisting of unordered pairs of elements of  $V(G)$  called *edges*. When the context is clear, we use  $V$  and  $E$  instead of  $V(G)$  and  $E(G)$  respectively. If  $V = \emptyset$ ,  $G$  is called *empty graph*. For notational simplicity, we write  $uv$  to represent the unordered pair  $\{u, v\}$  and  $u$  and  $v$  are called the *endpoints* of the edge  $uv$ . If  $u, v \in V(G)$  and  $uv \notin E(G)$ ,  $uv$  is called a *nonedge* of  $G$ . If  $uv \in E(G)$  we say that the vertex  $u$  is *adjacent to*  $v$  or viceversa. By  $|A|$  we denote the cardinal of a set  $A$ .  $\overline{G}$  denotes the *complement graph* of  $G$  whose vertex set is  $V(G)$  and whose edge set is formed by the set of nonedges of  $G$ . Notice that, nonedges in  $G$  are edges in  $\overline{G}$ . A *digraph*  $G$  is an ordered pair  $(N, D)$  formed by a set  $V$  called vertices and a set  $D$  of ordered pairs of elements of  $N$ .

Let  $G_1 = (V_1, E_1)$  and  $G_2 = (V_2, E_2)$  two graphs.  $G_1$  is said to be *isomorphic* to  $G_2$  and viceversa, if there exists a one-to-one function  $f : V_1 \rightarrow V_2$  preserving the adjacencies; i.e.  $vw \in E_1$  if and only if  $f(v_1)f(v_2) \in E_2$ .

Let  $G = (V, E)$  be a graph. The set of vertices adjacent to a vertex  $v \in V$  is called *neighborhood* of  $v$  and denoted by  $N_G(v)$ .  $N_G[v] := N_G(v) \cup \{v\}$  is defined to be the *close neighborhood* of  $v$ .  $d_G(v)$  denotes  $|N_G(v)|$  and is called the *degree* of  $v$ . Vertices with degree 0 and  $|V| - 1$  are called *isolated vertex* and *universal vertex*, respectively. A *pendant vertex* is a vertex of degree one.  $H = (V', E')$  is said to be a *subgraph* of  $G$  if  $V' \subseteq V$  and  $E' \subseteq E$ . If, in addition,  $E' = \{uv \in E : u, v \in V'\}$ ,  $H$  is called *induced subgraph* of  $G$  and we say that *the vertex set*  $V(H)$  *induces the graph*  $H$ . Given a subset  $A \subseteq V(G)$ ,  $G[A]$  stands for the subgraph induced by  $A$ . Two vertices  $u, v \in V$  are said to be *false twins* if  $N(v) = N(w)$  and they are said to be *true twins* if  $N[v] = N[w]$ . Let  $A, B \subseteq V(G)$ . We say that  $A \subseteq V$  is *complete to*  $B \subseteq V$  if every vertex of  $A$  is adjacent to every vertex of  $B$ ; and  $A$  is *anticomplete to*  $B$  if  $A$  is complete to  $B$  in  $\overline{G}$ .

Let  $G$  and  $H$  be two graphs. We say that a graph  $G$  *does not contain  $H$  as induced subgraph* or *does not contain an induced  $H$*  if any induced subgraph of  $G$  is not isomorphic to  $H$ . Given a collection of graphs  $\mathcal{H}$ ,  $G$  is defined to be  $\mathcal{H}$ -free if for any graph  $F \in \mathcal{H}$ ,  $G$  does not contain an induced  $F$ . If  $\mathcal{H}$  is a set with a single element  $H$ , we just use  $H$ -free for short. The *disjoint union* of  $G$  and  $H$  is the graph  $G \cup H$  whose vertex set is  $V(G) \cup V(H)$  and whose edge set is  $E(G) \cup E(H)$ . The disjoint union is clearly an associative operation, and for each nonnegative integer  $t$  we will denote by  $tG$  the disjoint union of  $t$  copies of  $G$ . The *join* of  $G$  and  $H$  is a graph  $G + H$  whose vertex set is  $V(G) \cup V(H)$  and whose edge set is  $E(G) \cup E(H) \cup \{vw : v \in V(G), w \in V(H)\}$ . If  $V(H) \subseteq V(G)$ , we denote by  $G - H$  the graph  $G[V(G) - V(H)]$ . If  $H$  is formed by an isolated vertex  $v$ ; i.e.,  $H$  is a subgraph of  $G$  whose vertex set is  $\{v\}$  and whose edge set is empty,  $G - v$  stands for  $G - H$ . Given  $E' \subseteq E(G)$ ,  $G - E'$  stands for the graph whose vertex set is  $V(G)$  and whose edge set is  $E(G) - E'$ .

Given a class of graphs  $\mathcal{G}$ , we denote by  $co\text{-}\mathcal{G}$  the class of graphs formed by the complements of graphs belonging to  $\mathcal{G}$ . A class of graph  $\mathcal{G}$  is said to be *hereditary* if for every  $G \in \mathcal{G}$ , any subgraph of it belongs to  $\mathcal{G}$ . We say that a graph  $G$  is *non- $\mathcal{G}$* , if  $G$  does not belong to the class  $\mathcal{G}$ . If  $\mathcal{G}$  is a hereditary class, a graph  $G$  is defined to be *minimally non- $\mathcal{G}$*  if  $G$  does not belong to  $\mathcal{G}$  but every proper induced subgraph does.

A *stable set* is a subset of pairwise non-adjacent vertices. A *complete set* is a set of pairwise adjacent vertices. A *complete graph* is a graph whose vertex set is a complete set. A *clique* is a complete graph maximal under inclusion.  $K_n$  ( $n \geq 0$ ) denotes the complete graph on  $n$  vertices.  $K_3$  is also called *triangle*. A *diamond* is the graph obtained from a complete  $K_4$  by removing exactly one edge. A *paw* is the graph obtained from a triangle  $T$  by adding a vertex adjacent to exactly one vertex of  $T$ . A *clique* is a subset of vertices inducing a complete subgraph. A graph  $G$  is *bipartite* if  $V(G)$  can be partitioned into two stable sets  $V_1, V_2$ ;  $G$  is *complete bipartite* if  $V_1$  is complete to  $V_2$ . Denote by  $K_{r,s}$  the complete bipartite graph with  $|V_1| = r$  and  $|V_2| = s$ . A *claw* is the complete bipartite graph  $K_{1,3}$ .

A *path* is a linear sequence of different vertices  $P = v_1, \dots, v_k$  such that  $v_i$  is adjacent to  $v_{i+1}$  for  $i = 1, \dots, k - 1$ .  $\{v_2, \dots, v_{k-1}\}$  are called *internal vertices* of the path. Sums in this paragraph should be understood modulo  $k$ . If there is no any edge  $v_i v_j$  such that  $|i - j| \geq 2$ ; i.e., all its internal vertices have degree two,  $P$  is said to be either *chordless path* or *induced path*. Denote by  $|P|$  the number of vertices of  $P$ . A cycle *cycle*  $C$  is a linear sequence of vertices  $C = v_1, \dots, v_k, v_1$  such that  $v_i$  is adjacent to  $v_{i+1}$  for  $i = 1, \dots, k$ . If there is no any edge  $v_i v_j$  such that  $|i - j| \geq 2$ ,  $C$  is said to be either *chordless cycle* or *induced cycle*. By  $P_n$  and  $C_n$  we denote a induced path and an induced cycle on  $n$  vertices, respectively. An edge

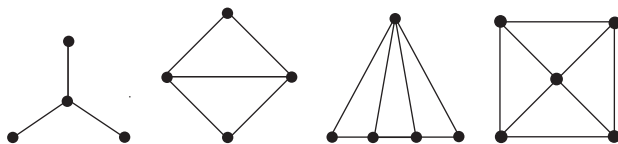

Figure 1.1: From left to right: claw, diamond, gem, and wheel

joining two non-consecutive vertices of a path or a cycle in a graph is called a *chord*. A *hole* is an induced cycle of length at least 4.

The operation of *edge subdivision* in a graph  $G$  consists on selecting an edge  $uv$  of  $G$  and replacing it with an induced path  $u = v_1, v_2 \dots, v_{k-1}, v_k = v$  with  $k \geq 3$  a positive integer. A *prism* is a graph that consists of two disjoint triangles  $\{a_1, a_2, a_3\}$  and  $\{b_1, b_2, b_3\}$  linked by three induced paths  $P_1, P_2, P_3$  where  $P_i$  links  $a_i$  and  $b_i$  for  $i = 1, 2, 3$ .

A graph  $G$  is called *connected* if there is a path linking any two of its vertices. A maximal (under inclusion) connected subgraph of  $G$  is called *component* of  $G$ . A graph  $G$  is *anticonnected* if  $\overline{G}$  is connected; an *anti-component* of  $G$  is the subgraph of  $G$  induced by the vertices of a component of  $\overline{G}$ .

Let  $G$  be a graph.  $v$  is called a *cut vertex* if the number of components of  $G - v$  is greater than the number of components of  $G$ .  $G$  is said to be *2-connected* if  $G$  is connected and does not have any cut vertex. A maximal 2-connected subgraph is called a *block*.

## 1.2 Overview on some classes of graphs

The aim of this section is to give a brief overview of some classes of graphs, especially those we use throughout this Thesis. The main focus is structural.

### 1.2.1 Domino graphs

A graph  $G$  is domino if all its vertices belong to at most two cliques. If, in addition, each of its edges belongs to at most one clique, then  $G$  is a linear domino graph.

The following theorem gives a forbidden induced subgraph characterization for the class of dominoes graphs.

**Theorem 1.** [KKM95]  *$G$  is a domino graph if and only if  $G$  is a  $\{gem, claw, 4\text{-wheel}\}$ -free graph.*

Notice that, given a graph  $G$ , then every edge belongs to at most one clique if and only if  $G$  is diamond-free. Consequently, the following corollary is obtained.

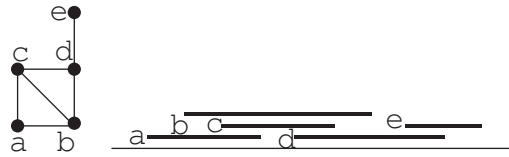

Figure 1.2: Interval graph and its interval model

**Corollary 1.** [KKM95]  *$G$  is a linear domino graph if and only if  $G$  is a  $\{\text{claw}, \text{diamond}\}$ -free graph.*

### 1.2.2 Intersection graphs

Given a family of sets  $\mathcal{F}$ , a graph  $G = (V, E)$  is defined to be an intersection graph respect on  $\mathcal{F}$  if there is a one-to-one function  $f : V \rightarrow \mathcal{F}$ , such that  $uv \in E$  if and only if  $f(u)$  and  $f(v)$  intersect. Intersection graphs have been widely studied in the literature. Having good structural qualities, interval graphs, chordal graphs, circular-arc graphs and circle graphs are some of the most studied intersection graph families. In this section we will focus on summarizing some features of some of the aforementioned classes of graphs.

#### Interval graphs

A graph  $G = (V, E)$  is defined to be an interval graph if there exists a family of open intervals  $\mathcal{I} = \{I_v\}_{v \in V}$  in the real line and a one-to-one function  $f : V \rightarrow \mathcal{I}$  such that  $uv \in E$  if and only if  $f(u)$  and  $I(v)$  intersect. Such a family of intervals  $\mathcal{I}$  is called an *interval model* of  $G$ .

Before introducing the well-known forbidden induced subgraph characterization for interval graphs, we will define a tool that play a very important role in this characterization. Three vertices in a graph  $G$  form an *asteroidal triple* if, for each two of three vertices, there exists a path containing those two but no neighbor of the third.

Boland and Lekerker characterized interval graph by forbidden induced subgraphs. They managed to do so having characterized interval graphs as those graphs not containing asteroidal triple [LB62].

**Theorem 2.** [LB62] *A graph is an interval graph if and only if it contains no induced bipartite-claw, umbrella,  $n$ -net for any  $n \geq 2$ ,  $n$ -tent for any  $n \geq 3$ , or  $C_n$  for any  $n \geq 4$ .*

Notice that all graphs depicted in Fig. 1.3 contain an asteroidal triple.

A *proper interval graph* is an interval graph having an interval model such that none of its intervals is properly contained in another, such an interval model is called *proper interval model*. A *unit interval* is an



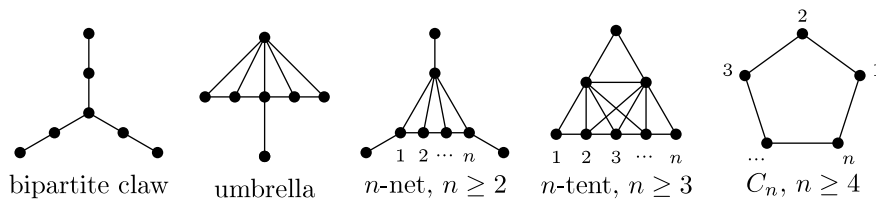

Figure 1.3: Minimal forbidden induced subgraphs for the class of interval graphs

interval graph having an interval model with all its intervals having the same length, such an interval model is called *unit interval model*.

Proper interval graphs were introduced by Roberts [Rob69]. It was himself that characterized those interval graphs that are proper interval.

**Theorem 3** ([Rob69]). *Let  $G$  be an interval graph.  $G$  is proper interval if and only if  $G$  does not contain an induced claw.*

Wegner [Weg67] and Robert [Rob69] introduced unit interval graphs. Notice that every unit interval graph is a proper interval graph. Roberts was able to prove that the converse is also true. Consequently, by combining Theorem 2 and Theorem 3 follows the below theorem.

**Theorem 4** ([Rob69]). *A graph is a unit interval graph if and only if it contains no induced claw, net, tent, or  $C_n$  for any  $n \geq 4$ .*

### Permutation graphs

In order to introduce permutation graphs we first define comparability graphs. We said that a digraph  $G' = (V', E')$  is an *orientation* of a graph  $G$  if  $V' = V(G)$  and  $uv \in E$  if and only if either  $(u, v) \in E'$  or  $(v, u) \in E'$ . An orientation is said to be a *transitive orientation* if it is a transitive binary relation on  $V'$ ; i.e., if  $(u, v) \in E'$  and  $(v, w) \in E'$ , then  $(u, w) \in E'$ . A graph is said to be *comparability* if it has a transitive orientation. Comparability graphs were characterized by Galai by means of a list of forbidden induced subgraphs [Gal67].

**Theorem 5.** [Gal67] *A graph is a comparability graph if and only if it does not contain as an induced subgraph any graph in Figure 1.4 and its complement does not contain as an induced subgraph any graph in Figure 1.6.*

Let  $\pi : \{1, \dots, n\} \rightarrow \{1, \dots, n\}$  be a permutation of  $V_n = \{1, \dots, n\}$ ; i.e,  $\pi$  is a one-to-one function. By  $G(\pi)$  we denote the graph whose vertex set is  $V_n$  and whose edge set is formed by those unordered pairs  $ij$  satisfying  $i < j$

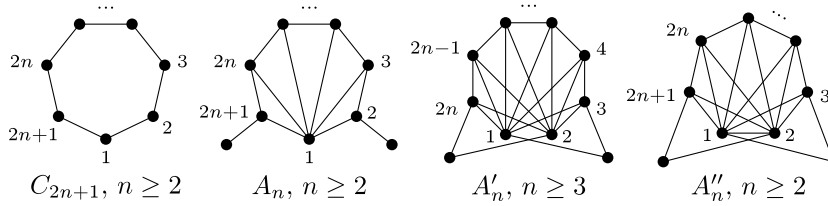

Figure 1.4: Some minimal forbidden induced subgraphs for comparability graphs.

and  $\pi^{-1}(i) > \pi^{-1}(j)$ . A graph  $G$  is defined to be a *permutation graph* if there exists a permutation  $\pi$  such that the graph  $G(\pi)$  is isomorphic to  $G$ . Notice that if you place  $\{1, \dots, n\}$  in two parallel vertical copies of the real line and join  $i$  of the line on the left with  $\pi(i)$  in the line on the right, the intersection graph of these segments is isomorphic to  $G(\pi)$ . For instance, consider the permutation  $\pi : V_4 \rightarrow V_4$  such that  $\pi(1) = 3$ ,  $\pi(2) = 1$ ,  $\pi(3) = 4$  and  $\pi(4) = 2$ , the graph  $G[\pi]$  is isomorphic to the intersection graph of the segments depicted in Figure 1.5. Pnueli et al. presented a characterization of permutation graphs that shows the relationship between this class and comparability graphs.

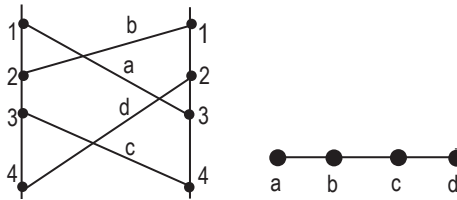

Figure 1.5: The intersection graph of the set of segments on the left whose endpoints belong to the vertical lines is isomorphic to the graph on the right.

**Theorem 6.** [PLE71] *A graph  $G$  is a permutation graph if and only if  $G$  and  $\overline{G}$  are comparability graphs.*

Therefore, the characterization of comparability graphs in [Gal67] leads immediately to a forbidden induced subgraph characterization of permutation graphs.

**Corollary 2.** *A graph  $G$  is a permutation graph if and only if  $G$  and  $\overline{G}$  do not contain as an induced subgraph any graph in Figure 1.4 and Figure 1.6.*

### Chordal graphs and its subclasses

A graph  $G$  is defined to be *chordal* if  $G$  does not contain any induced cycle with at least four vertices. Consequently, interval graphs are a subclass of

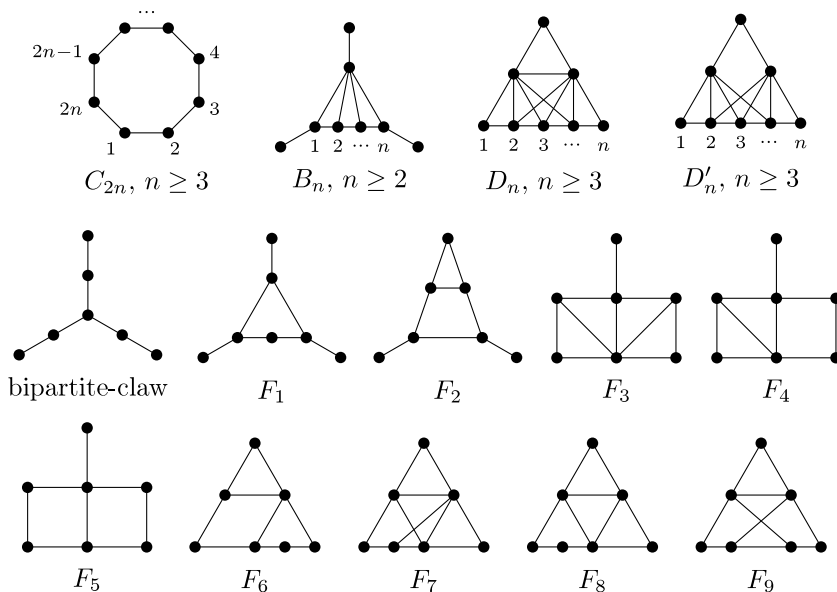

Figure 1.6: Some graphs whose complements are minimal forbidden induced subgraphs for comparability graphs.

chordal graphs. Furthermore, since the graph tent is chordal but not interval (see, Fig. 1.3), the class of interval graphs is properly contained in the class of chordal graphs. Chordal graphs were characterized as the intersection graph of subtrees in a tree [Gav74].

*Split graphs* are those graphs whose vertex set can be partitioned into two sets: a complete set and an stable set. Split graphs are a subclass of cographs and were characterized by forbidden induced subgraphs as follows.

**Theorem 7.** [HF77] *Let  $G$  be a graph.  $G$  is a split graph if and only if  $G$  does not contain any induced  $2K_2$ ,  $C_4$  and  $C_5$ .*

*Split complete graphs* are those split graphs such that can be partitioned into a stable set and a complete set in such a way that the complete set is complete to the stable set. Split complete graphs will be also called *probe complete*. The above theorem implies the following result whose proof is straightforward.

**Lemma 1.** *Let  $G$  be a graph.  $G$  is split complete if and only if  $G$  does not contain any induced  $C_4$  and  $\overline{P}_3$ .*

$G$  is a *block graph* if it is connected and every block is a complete. It is well-known that block graphs are connected diamond-free chordal graphs.

Given two vertices  $v$  and  $w$  of a connected graph  $G$ ,  $d(v, w)$  stands for the number of edges of a path with the minimum number of edges linking  $v$  and  $w$ .

A connected graph is defined to be *ptolemaic* if and only if it satisfies the ptolemaic inequality; i.e., for any four vertices  $u, v, w$  and  $x$

$$d(u, v)d(w, x) \leq d(u, w)d(v, x) + d(u, x)d(v, w).$$

Howorka proved that a graph is ptolemaic if and only if it is chordal and gem-free [How81](see  $F_2$  in Fig. 5.2).

### 1.2.3 Cographs and its superclasses

In this section we are going to overview the most important structural characterization of cograph and some of its superclasses. First, we will start defining cographs recursively.

A *cograph* can be recursively constructed as follows:

1. The trivial graph is a cograph.
2. If  $G_1$  and  $G_2$  are cographs, then  $G_1 \cup G_2$  is a cograph.
3. If  $G$  is a cograph, then  $\overline{G}$  is a cograph.

There are several ways of characterizing cographs (see e.g., [CO00, CLS81, CPS84, Sei74]). Next, we give a characterization by forbidden induced subgraph for this class.

**Theorem 8.** [CLS81, CPS84] *Let  $G = (V, E)$  a graph.  $G$  is a cograph if and only if  $G$  is  $P_4$ -free.*

The following theorem shows a property of cographs which is a useful tool to deal with this class.

**Theorem 9.** [Sei74] *If  $G$  is a cograph, then  $G$  is either not connected or not anticonnected.*

Let  $G$  be a graph and let  $A$  be a vertex set inducing a  $P_4$  in  $G$ . A vertex  $v$  of  $G$  is said a *partner* of  $A$  if  $G[A \cup \{v\}]$  contains at least two induced  $P_4$ 's. Finally,  $G$  is called  *$P_4$ -tidy* if each vertex set  $A$  inducing a  $P_4$  in  $G$  has at most one partner [GRT97].

The class of  $P_4$ -tidy graphs is an extension of the class of cographs and it contains many other graph classes defined by bounding the number of  $P_4$ 's according to different criteria; e.g.,  $P_4$ -sparse graphs [Hoà85],  $P_4$ -lite graphs [JO89], and  $P_4$ -extendible graphs [JO91].

A *spider* [Hoà85] is a graph whose vertex set can be partitioned into three sets  $S$ ,  $C$ , and  $R$ , where  $S = \{s_1, \dots, s_k\}$  ( $k \geq 2$ ) is a stable set;  $C = \{c_1, \dots, c_k\}$  is a complete set;  $s_i$  is adjacent to  $c_j$  if and only if  $i = j$  (a *thin spider*), or  $s_i$  is adjacent to  $c_j$  if and only if  $i \neq j$  (a *thick spider*);  $R$

is allowed to be empty and if it is not, then all the vertices in  $R$  are adjacent to all the vertices in  $C$  and nonadjacent to all the vertices in  $S$ . The triple  $(S, C, R)$  is called the *spider partition*. Clearly, the complement of a thin spider is a thick spider, and vice versa. A *fat spider* is obtained from a spider by adding a true or false twin of a vertex  $v \in S \cup C$ . The following theorem characterizes the structure of  $P_4$ -tidy graphs.

**Theorem 10.** [GRT97] *Let  $G$  be a  $P_4$ -tidy graph with at least two vertices. Then, exactly one of the following conditions holds:*

1.  $G$  is disconnected.
2.  $\overline{G}$  is disconnected.
3.  $G$  is isomorphic to  $P_5$ ,  $\overline{P_5}$ ,  $C_5$ , a spider, or a fat spider.

Let  $G$  be a graph and let  $A$  be a vertex set that induces a  $P_4$  in  $G$ . A vertex  $v$  of  $G$  is said a *partner* of  $A$  if  $G[A \cup \{v\}]$  contains at least two induced  $P_4$ 's. Finally,  $G$  is called  *$P_4$ -tidy* if each vertex set  $A$  that induces a  $P_4$  in  $G$  has at most one partner [GRT97]. The class of  $P_4$ -tidy graphs is an extension of the class of cographs and it contains many other graph classes defined by bounding the number of  $P_4$ 's according to different criteria; e.g.,  $P_4$ -sparse graphs,  $P_4$ -lite graphs [JO89], and  $P_4$ -extendible graphs [JO91]. A *spider* is a graph whose vertex set can be partitioned into three sets  $S$ ,  $C$ , and  $R$ , where  $S = \{s_1, \dots, s_k\}$  ( $k \geq 2$ ) is a stable set;  $C = \{c_1, \dots, c_k\}$  is a complete set;  $s_i$  is adjacent to  $c_j$  if and only if  $i = j$  (a *thin spider*), or  $s_i$  is adjacent to  $c_j$  if and only if  $i \neq j$  (a *thick spider*);  $R$  is allowed to be empty and if it is not, then all the vertices in  $R$  are adjacent to all the vertices in  $C$  and nonadjacent to all the vertices in  $S$ . The triple  $(S, C, R)$  is called the *spider partition*. Clearly, the complement of a thin spider is a thick spider, and vice versa. A *fat spider* is obtained from a spider by adding a true or false twin of a vertex  $v \in S \cup C$ .

*Tree-cographs* [Tin89] are another generalization of cographs. They are defined recursively as follows: trees are tree-cographs; the disjoint union of tree-cographs is a tree-cograph; and the complement of a tree-cograph is also a tree-cograph. It is immediate from the definition that, if  $G$  is a tree-cograph, then  $G$  or  $\overline{G}$  is disconnected, or  $G$  or  $\overline{G}$  is a tree.



## Chapter 2

# Circular-arc graphs

### 2.1 Introduction

A graph  $G$  is a *circular-arc* ( $CA$ ) graph if it is the intersection graph of a set  $S$  of arcs on a circle, i.e., if there exists a one-to-one function  $f : V \rightarrow S$  such that two vertices  $u, v \in V(G)$  are adjacent if and only the arcs  $f(u)$  and  $f(v)$  intersect. Such a family of arcs is called a *circular-arc model* ( $CA$  model) of  $G$ .  $CA$  graphs can be recognized in linear time [McC03]. Notice that a graph is an interval graph if it admits a  $CA$  model such that the set of arcs does not cover the circle. Interval graphs have been characterized by minimal forbidden induced subgraphs [LB62] (see Chapter 1, Section 1.2). A graph  $G$  is a *proper circular-arc* ( $PCA$ ) graph if it admits a  $CA$  model in which no arc is contained in another arc. Tucker gave a characterization of  $PCA$  graphs by minimal forbidden induced subgraphs [Tuc74]. Furthermore, this subclass can be recognized in linear time [DHH96]. A graph  $G$  is a *unit circular-arc* ( $UCA$ ) graph if it admits a  $CA$  model in which all the arcs have the same length. Tucker gave a characterization by minimal forbidden induced subgraphs for this class [Tuc74]. Recently, linear and quadratic-time recognition algorithms for this class have been shown [LS06b, DGM<sup>+</sup>06]. Finally, the class of  $CA$  graphs that are complements of bipartite graphs was characterized by minimal forbidden induced subgraphs [TM76]. Nevertheless, the problem of characterizing the whole class of  $CA$  graphs by forbidden induced subgraphs remains open. In this chapter we present some steps in this direction by providing characterizations of  $CA$  graphs by minimal forbidden induced subgraphs when the graph belongs to any of four different classes:  $P_4$ -free graphs, paw-free graphs, claw-free chordal graphs and diamond-free graphs. All of these classes were studied along the way towards the proof of the Strong Perfect Graph Theorem [Con89, Ola88, PR76, Sei74, Tuc87]. The results presented in this chapter were published in [BDGS09].

## 2.2 Preliminaries

### 2.2.1 Definitions

Denote by  $G^*$  the graph obtained from  $G$  by adding an isolated vertex. If  $t$  is a non-negative integer, then  $tG$  will denote the disjoint union of  $t$  copies of  $G$ . A graph  $G$  is a *multiple* of another graph  $H$  if  $G$  can be obtained from  $H$  by replacing each vertex  $x$  of  $H$  by a non-empty complete graph  $M_x$  and adding all possible edges between  $M_x$  and  $M_y$  if and only if  $x$  and  $y$  are adjacent in  $H$ .

Let  $G$  and  $H$  be graphs.  $G$  is an *augmented*  $H$  if  $G$  is isomorphic to  $H$  or if  $G$  can be obtained from  $H$  by repeatedly adding a universal vertex.  $G$  is a *bloomed*  $H$  if there exists a subset  $W \subseteq V(G)$  such that  $G[W]$  is isomorphic to  $H$  and  $V(G) - W$  is either empty or it induces in  $G$  a disjoint union of non-empty complete graphs  $B_1, B_2, \dots, B_j$  for some  $j \geq 1$ , where each  $B_i$  is complete to one vertex of  $G[W]$ , but anticomplete to any other vertex of  $G[W]$ . If each vertex in  $W$  is complete to at least one of  $B_1, B_2, \dots, B_j$ , we say that  $G$  is a *fully bloomed*  $H$ . The complete graphs  $B_1, \dots, B_j$  will be referred as the *blooms*. A bloom is *trivial* if it is composed of only one vertex.

### 2.2.2 Previous results

Special graphs needed throughout this chapter are depicted in Figure 2.1. For notational simplicity, in this chapter, we will use *net* and *tent* as abbreviations for 2-net and 3-tent, respectively.

Bang-Jensen and Hell proved the following result.

**Theorem 11.** [BH94] *Let  $G$  be a connected graph containing no induced claw, net,  $C_4$ , or  $C_5$ . If  $G$  contains a tent as induced subgraph, then  $G$  is a multiple of a tent.*

Theorem 11 allows to provide the following description of all the minimal non-PCA graphs within the class of connected chordal graphs.

**Theorem 12.** [BH94] *Let  $G$  be a connected chordal graph. Then,  $G$  is PCA if and only if it contains no induced claw or net.*

Remind that Lekkerkerker and Boland determined all the minimal forbidden induced subgraphs for the class of interval graphs (cf. Chapter 1, Theorem 2). This characterization yields some minimal forbidden induced subgraphs for the class of CA graphs. Let  $H$  be a minimal forbidden induced subgraph for the class of interval graphs. Notice that if  $H$  is non-CA,

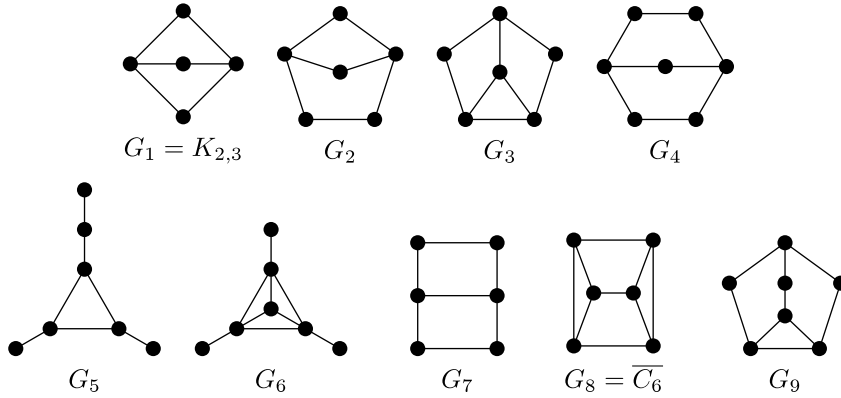

Figure 2.1: Some minimally non- $CA$  graphs.

then  $H$  is minimally non- $CA$ . Otherwise, if  $H$  is  $CA$ , then  $H^*$  is minimally non- $CA$ , and furthermore all non-connected minimally non- $CA$  graphs are obtained this way. Since the umbrella, net,  $n$ -tent for all  $n \geq 3$ , and  $C_n$  for all  $n \geq 4$  are  $CA$ , but the bipartite claw and  $n$ -net for all  $n \geq 3$  are not, this observation and Theorem 2 lead to the following result.

**Corollary 3.** [TM76] *The following graphs are minimally non- $CA$  graphs: bipartite claw, net\*,  $n$ -net for all  $n \geq 3$ , umbrella\*,  $(n$ -tent)\* for all  $n \geq 3$ , and  $C_n^*$  for every  $n \geq 4$ . Any other minimally non- $CA$  graph is connected.*

We call the graphs listed in Corollary 3 *basic* minimally non- $CA$  graphs. Any other minimally non- $CA$  graph will be called *non-basic*. The following result, which gives a structural property for all non-basic minimally non- $CA$  graphs, can be deduced from Theorem 2 and Corollary 3.

**Corollary 4.** *If  $G$  is a non-basic minimally non- $CA$  graph, then  $G$  has an induced subgraph  $H$  that is isomorphic to an umbrella, a net, a  $j$ -tent for some  $j \geq 3$ , or  $C_j$  for some  $j \geq 4$ . In addition, each vertex  $v$  of  $G - H$  is adjacent to at least one vertex of  $H$ .*

*Proof.* Since  $G$  is non- $CA$ , in particular,  $G$  is not an interval graph. By Theorem 2,  $G$  has an induced subgraph  $H$  isomorphic to a bipartite claw, umbrella,  $j$ -net for  $j \geq 2$ ,  $j$ -tent for  $j \geq 3$ , or  $C_j$  for some  $j \geq 4$ . Since  $G$  is non-basic minimally non- $CA$ ,  $H$  is isomorphic to umbrella, net,  $j$ -tent for some  $j \geq 3$ , or  $C_j$  for some  $j \geq 4$ . Moreover, since  $G$  is not isomorphic to  $H^*$ , every vertex  $v$  of  $G - H$  is adjacent to at least one vertex of  $H$ .  $\square$

Figure 2.1 introduces the graphs  $G_i$ , for  $i \in \{1, 2, \dots, 9\}$ .

**Theorem 13.** *Let  $G$  be a minimally non-CA graph. If  $G$  is not isomorphic to  $K_{2,3}$ ,  $G_2$ ,  $G_3$ ,  $G_4$ , or  $C_j^*$ , for  $j \geq 4$ , then for every hole  $H$  of  $G$  and for each vertex  $v$  of  $G - H$ , either  $v$  is complete to  $H$ , or  $N_H(v)$  induces a non-empty path in  $H$ .*

*Proof.* Let  $G$  be a minimally non-CA graph, and suppose that  $G$  is not isomorphic to  $K_{2,3}$ ,  $G_2$ ,  $G_3$ ,  $G_4$ , or  $C_j^*$  for  $j \geq 4$ . Suppose, by way of contradiction, that there is a hole  $H$  of  $G$  and there is a vertex  $v$  of  $G - H$  such that  $v$  is not complete to  $H$  and  $N_H(v)$  does not induce a path in  $H$ . Note that  $N_H(v)$  is non-empty because  $G$  is minimally non-CA and it is not isomorphic to  $C_j^*$  for  $j \geq 4$ .

So,  $H - N_H(v)$  is non-empty and is neither a path nor a hole, hence it is not connected. Let  $Q_1$  and  $Q_2$  be two components of  $H - N_H(v)$ . Then, there are induced paths  $P^1$  and  $P^2$  on  $H$  such that the interior vertices of  $P^i$  are  $Q_i$ , for  $i = 1, 2$ . Therefore, the following conditions hold:

1. each of  $P^1$  and  $P^2$  has at least three vertices,
2.  $v$  is adjacent to none of the interior vertices of  $P^1$  and  $P^2$ , and
3.  $v$  is adjacent to the endpoints of  $P^1$  and the endpoints of  $P^2$ .

By definition,  $P^1$  and  $P^2$  have no interior vertices in common.

Suppose, by way of contradiction, that  $P^1$  and  $P^2$  have no common endpoints. Let  $w$  be an interior vertex of  $P^1$ , so  $w$  is anticomplete to the hole induced by  $\{v\} \cup V(P^2)$  on  $G$ . Then,  $\{v, w\} \cup V(P^2)$  induces a proper subgraph of  $G$  (it is proper since it does not contain the endpoints of  $P^1$ ) that is not a CA graph, a contradiction.

Suppose next that  $P^1$  and  $P^2$  have exactly one endpoint in common. Suppose, by way of contradiction, that  $P^1$  has at least two interior vertices. Then, there is an interior vertex  $w$  of  $P^1$  that is non-adjacent to the common endpoint of  $P^1$  and  $P^2$ . Since  $\{w\}$  is anticomplete to  $\{v\} \cup V(P^2)$ ,  $\{v, w\} \cup V(P^2)$  induces a proper subgraph in  $G$  (it is proper because it does not contain the endpoint of  $P^1$  that is not a vertex of  $P^2$ ) that is non-CA, a contradiction. This contradiction proves that each one of  $P^1$  and  $P^2$  has exactly one interior vertex. Then,  $\{v\} \cup V(P^1) \cup V(P^2)$  would induce on  $G$  a subgraph isomorphic to either  $G_3$  or  $G_7$ , both of which are non-CA graphs. Since  $G$  is minimally non-CA,  $V(G) = \{v\} \cup V(P^1) \cup V(P^2)$ . Since  $V(P^1) \cup V(P^2) \subseteq V(H)$ , necessarily  $V(H) = V(P^1) \cup V(P^2)$ . Since  $H$  induces a hole in  $G$ ,  $G$  is isomorphic to  $G_3$ , a contradiction.

Finally suppose that  $P^1$  and  $P^2$  have exactly two endpoints in common. Suppose, by way of contradiction, that  $P^1$  has more than two interior

---

points. Let  $w$  be an interior vertex of  $P^1$  that is adjacent to none of its endpoints. Then,  $w$  is anticomplete to  $\{v\} \cup V(P^2)$  and thus  $\{v, w\} \cup V(P^2)$  induces a proper subgraph on  $G$  (it is proper because it does not contain the neighbours of  $w$  in  $H$ ) that is non- $CA$ , a contradiction. This contradiction shows that each one of  $P^1$  and  $P^2$  has at most two interior vertices. Thus,  $\{v\} \cup V(P^1) \cup V(P^2)$  induces on  $G$  either  $K_{2,3}$ ,  $G_2$  or  $G_4$ , which are minimally non- $CA$  graphs. Since  $G$  is minimally non- $CA$ ,  $G$  is isomorphic to one of them, a contradiction.  $\square$

## 2.3 Partial characterizations

### 2.3.1 Cographs

Results on cographs used throughout this subsection can be found in Subsection 1.2.3.

Define *semicircular graphs* to be the intersection graphs of open semicircles on a circle. Notice that semicircular graphs are  $UCA$  graphs.

**Theorem 14.** *Let  $G$  be a graph. The following conditions are equivalent:*

1.  $G$  is  $\{P_4, 3K_1\}$ -free.
2.  $G$  is an augmented multiple of  $\overline{tK_2}$  for some non-negative integer  $t$ .
3.  $G$  is a semicircular graph.

*Proof.* (1)  $\Rightarrow$  (2) Assume that  $G$  is a  $\{P_4, 3K_1\}$ -free graph. If  $G$  has less than two vertices, then  $G$  is a complete (note that  $\overline{tK_2}$  with  $t = 0$  is an empty graph). So, we can assume that  $G$  has at least two vertices. Since  $G$  is  $P_4$ -free, by Theorem 9,  $G$  is either not connected or not anticonnected.

Since  $G$  is  $3K_1$ -free, if  $G$  is not connected, then  $G$  has exactly two components. Moreover, both components are complete graphs. Thus,  $G$  is a multiple of  $\overline{K_2}$ . Suppose now that  $G$  is non-anticonnected, and let  $H$  be an anticomponent of  $G$ . Since  $H$  is  $\{P_4, 3K_1\}$ -free and anticonnected,  $H$  is either trivial or non-connected and, in the second case, by the arguments above  $H$  induces on  $G$  a multiple of  $\overline{K_2}$ . Let  $s$  be the number of anticomponents of  $G$  that are trivial and  $t$  be the number of anticomponents of  $G$  that induce on  $G$  a multiple of  $\overline{K_2}$ . Since  $G$  is the join of its anticomponents,  $G$  is the join of a multiple of  $\overline{tK_2}$  and a complete  $K_s$  for some non-negative integers  $t$  and  $s$ . Consequently,  $G$  is an augmented multiple of  $\overline{tK_2}$  for some non-negative integer  $t$ .

(2)  $\Rightarrow$  (3) Assume that  $G$  is an augmented multiple of  $\overline{tK_2}$  for some non-negative  $t$ . In particular,  $G$  is a multiple of  $\overline{tK_2 \cup sK_1}$  for some non-negative

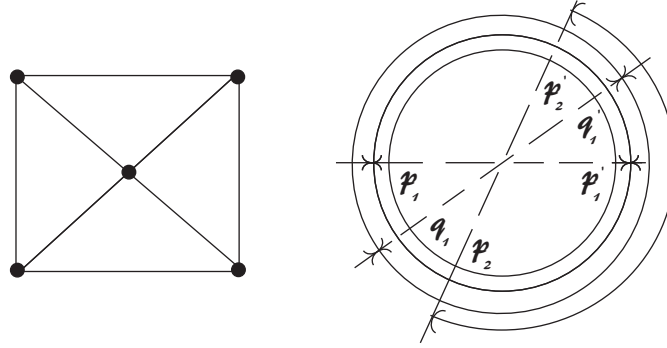

Figure 2.2: The graph  $\overline{2K_2 \cup K_1}$  and its semicircular model.

$t$  and some  $s = 0$  or  $1$ . In order to prove that  $G$  is a semicircular graph, it suffices to prove that  $\overline{tK_2 \cup sK_1}$  is a semicircular graph. Fix a circle  $C$ . Let  $\{p_1, p'_1\}, \dots, \{p_t, p'_t\}, \{q_1, q'_1\}, \dots, \{q_s, q'_s\}$  be  $t + s$  pairwise distinct pairs of antipodal points of  $C$ . For  $i = 1, \dots, t$ , let  $S_i^1$  and  $S_i^2$  be the two disjoint open semicircles on  $C$  whose endpoints are  $p_i$  and  $p'_i$ . For  $j = 1, \dots, s$  let  $T_j$  be an open semicircle on  $C$  whose endpoints are  $q_j$  and  $q'_j$ . Then  $S_1^1, S_1^2, \dots, S_t^1, S_t^2, T_1, \dots, T_s$  is a semicircular model for  $\overline{tK_2 \cup sK_1}$  (see Fig. 2.2).

(3)  $\Rightarrow$  (1) We now prove that semicircular graphs are  $\{P_4, 3K_1\}$ -free graphs. It is clear that  $3K_1$  is not a semicircular graph because there is not enough space on a circle for three pairwise disjoint semicircles. We now show that  $P_4$  is not a semicircular graph. Assume, by way of contradiction, that there is a semicircular graph model for  $P_4$ . Let  $V(P_4) = \{v_1, v_2, v_3, v_4\}$ , where  $v_i$  is adjacent to  $v_{i+1}$  for  $i = 1, 2, 3$  and let  $S = \{S_1, S_2, S_3, S_4\}$  be a semicircular model for  $P_4$ , where the semicircle  $S_i$  corresponds to the vertex  $v_i$ . Since  $v_1$  and  $v_3$  are non-adjacent,  $S_1$  and  $S_3$  are disjoint and have the same endpoints. Since  $v_1$  and  $v_4$  are also non-adjacent, the same holds for  $S_1$  and  $S_4$ , hence  $S_3 = S_4$ . This contradicts the fact that  $S_2 \cap S_3$  is non-empty but  $S_2 \cap S_4$  is empty. This contradiction shows that  $P_4$  is not a semicircular graph. Since the class of semicircular graphs is hereditary, a semicircular graph is  $\{3K_1, P_4\}$ -free.  $\square$

**Theorem 15.** *Let  $G$  be a cograph that contains an induced  $C_4$ , and such that all its proper induced subgraphs are CA graphs. Then, exactly one of the following conditions holds:*

1.  $G$  is isomorphic to  $K_{2,3}$  or  $C_4^*$ .
2.  $G$  is an augmented multiple of  $\overline{tK_2}$ , for some integer  $t \geq 2$ .

*Proof.* Clearly,  $K_{2,3}$  and  $C_4^*$  are not augmented multiples of  $\overline{tK_2}$ , for any integer  $t \geq 2$ . Assume that  $G$  is isomorphic to neither  $C_4^*$  nor  $K_{2,3}$ . Since all proper induced subgraphs of  $G$  are  $CA$  graphs,  $C_4^*$  and  $K_{2,3}$  are not proper induced subgraphs of  $G$ . We must prove that  $G$  is an augmented multiple of  $\overline{tK_2}$ , for some integer  $t \geq 2$ . Let  $H$  be the induced subgraph of  $G$  that is isomorphic to  $C_4$ . Since  $C_4 = \overline{2K_2}$ , we may suppose that there is a vertex  $v$  in  $G - H$ . Since  $C_4^*$  is not an induced subgraph of  $G$ ,  $v$  is adjacent to at least one vertex of  $H$ . Since  $G$  is  $\{P_4, K_{2,3}\}$ -free, either  $v$  is adjacent to three vertices of  $H$  or  $v$  is complete to  $H$ . In case that  $v$  is adjacent to three vertices of  $H$  we will denote by  $C(v)$  the interior vertex of the path induced by  $N_H(v)$  in  $H$ . Suppose there exists a vertex  $w$  of  $G - H$ ,  $w \neq v$ , that is non-adjacent to  $v$ . If  $v$  were adjacent to three vertices of  $H$  and  $w$  were complete to  $H$ , then the subgraph induced by  $\{v, w\} \cup V(H)$  in  $G$  would contain an induced  $P_4$ , a contradiction. Thus,  $v$  and  $w$  are both adjacent to three vertices of  $H$  or they are both complete to  $H$ . Next assume that  $v$  and  $w$  are both adjacent to three vertices of  $G$ . If  $C(v) = C(w)$ , then  $\{v, w\} \cup (V(H) - \{C(v)\})$  would induce in  $G$  a graph isomorphic to  $K_{2,3}$ . If  $C(v)$  and  $C(w)$  were adjacent, then  $\{v, w\} \cup V(H)$  would contain an induced  $P_4$ . We conclude that if  $v$  and  $w$  are both adjacent to three vertices of  $H$ , then  $C(v)$  and  $C(w)$  must be distinct and non-adjacent vertices of  $H$ .

We now prove that  $G$  does not contain  $3K_1$  as induced subgraph. Assume, by way of contradiction, that there is an induced subgraph  $S$  of  $G$  isomorphic to  $3K_1$ . Clearly  $H$  and  $S$  have at most two vertices in common. If  $H$  and  $S$  had two vertices in common, then the remaining vertex of  $S$  would be a vertex of  $G - H$  adjacent to at most two vertices of  $H$ , a contradiction. If  $H$  and  $S$  had exactly one vertex in common, then the other two vertices of  $S$  would be adjacent to the same three vertices of  $H$ . As we noticed above, this leads to a contradiction. We conclude that  $H$  and  $S$  must have no vertices in common. Let  $\{v_1, v_2, v_3\} = V(S)$ . Since the vertices of  $S$  are vertices of  $G - H$  and pairwise non-adjacent, all of them are adjacent to three vertices of  $H$  or all of them are complete to  $H$ . If all of them were adjacent to three vertices of  $H$ , then  $C(v_1), C(v_2), C(v_3)$  would be pairwise distinct and non-adjacent vertices of  $H$ , a contradiction. If all of them were complete to  $H$ , then  $H \cup \{v_1, v_2, v_3\}$  induces in  $G$  a graph which contains an induced  $K_{2,3}$ , a contradiction. We conclude that  $G$  is  $3K_1$ -free. Since  $G$  is also  $P_4$ -free, by Theorem 14,  $G$  is an augmented multiple of  $\overline{tK_2}$ . Finally, since  $G$  contains  $C_4$  as an induced subgraph,  $t \geq 2$ .  $\square$

We can now present the main characterization of this subsection.

**Theorem 16.** *Let  $G$  be a cograph. Then,  $G$  is a  $CA$  graph if and only if  $G$  contains no induced  $K_{2,3}$  or  $C_4^*$ .*

*Proof.* Let  $H$  be a cograph. Suppose, by way of contradiction, that  $H$  is a minimally non- $CA$  graph but  $H$  is not isomorphic to  $K_{2,3}$  or  $C_4^*$ . Since  $H$  is not an interval graph and it is  $P_4$ -free, by Theorem 2,  $H$  contains an induced  $C_4$ . By Theorem 15,  $H$  is an augmented multiple of  $\overline{tK_2}$ , for some  $t \geq 2$ . Thus, by Theorem 14,  $H$  is a  $CA$  graph, a contradiction.  $\square$

### 2.3.2 Paw-free graphs

A *paw-free* graph is a graph with no induced paw. Paw-free graphs were studied in [Ola88].

**Theorem 17.** *Let  $G$  be a paw-free graph containing an induced  $C_4$  and such that all its proper induced subgraphs are  $CA$  graphs. Then, at least one of the following conditions holds:*

1.  $G$  is isomorphic to  $K_{2,3}$ ,  $G_2$ ,  $G_7$ , or  $C_4^*$ .
2.  $G$  is a bloomed  $C_4$  with trivial blooms.
3.  $G$  is an augmented multiple of  $\overline{tK_2}$  for some  $t \geq 2$ .

*Proof.* Assume that  $G$  is not isomorphic to  $K_{2,3}$ ,  $G_2$ ,  $G_7$ , or  $C_4^*$ . Since all proper induced subgraphs of  $G$  are  $CA$ ,  $G$  does not contain any of these graphs as induced subgraphs.

Let  $H$  be an induced subgraph of  $G$  isomorphic to  $C_4$ . If  $G = H$ , then the theorem holds. Otherwise, let  $v$  be any vertex of  $G - H$ . Since  $G$  is  $C_4^*$ -free,  $v$  is adjacent to at least one vertex of  $H$ . Since  $G$  is paw-free,  $v$  cannot be adjacent to either exactly three vertices of  $H$  or exactly two adjacent vertices of  $H$ . Since  $G$  is  $K_{2,3}$ -free,  $v$  cannot be adjacent to exactly two non-adjacent vertices of  $H$ . We conclude that each vertex  $v$  of  $G - H$  is either adjacent to exactly one vertex of  $H$  or complete to  $H$ .

Suppose that there are two vertices  $w, w'$  in  $G - H$  such that  $w$  is complete to  $H$  and  $w'$  is adjacent to exactly one vertex  $x$  of  $H$ . If  $w$  and  $w'$  are non-adjacent, then  $w, w', x$  and any neighbour of  $x$  in  $H$  induce a paw in  $G$ ; if  $w$  and  $w'$  are adjacent, then  $w, w', x$  and the non-neighbour of  $x$  in  $H$  induce a paw in  $G$ . Since  $G$  is paw-free, either all vertices of  $G - H$  are complete to  $H$ , or each vertex of  $G - H$  is adjacent to exactly one vertex of  $H$  (not necessarily all of them to the same vertex).

Assume first that each vertex of  $G - H$  is adjacent to exactly one vertex of  $H$ . Let us prove that  $G - H$  is a stable set. Assume, by way of contradiction, that there are two adjacent vertices  $v$  and  $w$  in  $G - H$ . Since  $G$  is paw-free,  $v$  and  $w$  cannot be adjacent to the same vertex. Since  $G$  contains no induced  $G_7$ ,  $v$  and  $w$  must be adjacent to non-adjacent vertices of  $H$ . Similarly, since  $G$  contains no induced  $G_2$ ,  $v$  and  $w$  cannot be adjacent to non-adjacent vertices of  $H$ , a contradiction. Thus,  $G - H$  is a stable set.

Since each vertex of  $G - H$  is adjacent to exactly one vertex of  $H$ ,  $G$  is a bloomed  $C_4$  with trivial blooms.

Assume now that all vertices of  $G - H$  are complete to  $H$ . If  $G - H$  contains three pairwise non-adjacent vertices, then these vertices and two non-adjacent vertices of  $H$  induce  $K_{2,3}$ , a contradiction. If  $G - H$  contains  $P_4$ , then three non-consecutive vertices of  $P_4$  and any vertex of  $H$  induce a paw, a contradiction. Thus,  $G - H$  is  $\{3K_1, P_4\}$ -free. Since  $H$  is complete to  $G - H$ , every induced subgraph of  $G$  with at least one vertex in  $H$  and at least one vertex in  $G - H$  is non-anticonnected. Since  $P_4$  and  $3K_1$  are anticonnected, if  $G$  contains an induced subgraph isomorphic to either  $3K_1$  or  $P_4$ , then it must be entirely contained in either  $H$  or  $G - H$ . As observed above, this situation is not possible, hence  $G$  is  $\{3K_1, P_4\}$ -free. By Theorem 14,  $G$  is an augmented multiple of  $\overline{tK_2}$  for some non-negative  $t$ . Finally, since  $G$  contains an induced  $C_4$ ,  $t \geq 2$ .  $\square$

**Theorem 18.** *Let  $k \geq 5$ . Let  $G$  be a paw-free graph such that all its proper induced subgraphs are CA graphs. If  $G$  contains an induced subgraph  $H$  isomorphic to  $C_k$ , then exactly one of the following conditions holds:*

1.  $G$  is isomorphic to  $G_2$ ,  $G_4$ , or  $C_k^*$ .
2.  $G$  is a bloomed  $C_k$  with trivial blooms.

*Proof.* Assume that  $G$  is not isomorphic to  $G_2$ ,  $G_4$ , or  $C_k^*$ . Since all proper induced subgraphs of  $G$  are CA,  $G$  does not contain any of these graphs as induced subgraph. Moreover,  $G$  contains no induced  $C_j^*$ , for any  $j \geq 4$ .  $G$  is paw-free, so it is not isomorphic to  $G_3$ ;  $G$  contains an induced cycle of length at least five, so it is not isomorphic to  $K_{2,3}$ . If  $G = H$ , then the theorem holds. Otherwise, by Theorem 13, if  $v$  is a vertex of  $G - H$ , then either  $v$  is complete to  $H$  or  $N_H(v)$  induces a non-empty path on  $H$ . But, since  $H$  is isomorphic to  $C_k$ ,  $k \geq 5$ , and  $G$  is paw-free, every vertex of  $G - H$  must be adjacent to exactly one vertex of  $H$ . We will show now that  $G - H$  is a stable set of  $G$ . Let  $v$  and  $w$  be two vertices of  $G - H$ . Suppose, by way of contradiction, that  $v$  and  $w$  are adjacent. Since  $G$  is paw-free,  $v$  and  $w$  cannot be adjacent to the same vertex of  $H$ . If  $v$  and  $w$  were adjacent to two adjacent vertices of  $H$ , then  $G$  would properly contain an induced  $C_4^*$ . We can assume now that  $v$  and  $w$  are adjacent to non-adjacent vertices of  $H$ . Let  $P^1$  and  $P^2$  be the two distinct paths joining the neighbours of  $v$  and  $w$  within  $H$ . By hypothesis, each of  $P^1$  and  $P^2$  has at least three vertices, and at least one of them has four vertices, since  $H$  has at least five vertices. Since  $G$  contains no induced  $C_j^*$ ,  $j \geq 4$ , each of  $P^1$  and  $P^2$  has at most four vertices. If  $P^1$  and  $P^2$  have three and four vertices respectively, then  $\{v, w\} \cup V(H)$  would induce in  $G$  the graph  $G_4$ , a contradiction. Finally, if each of  $P^1$  and  $P^2$  has four vertices, then  $\{v, w\} \cup V(H) - N_H(v)$  induces

properly on  $G$  a bipartite claw, a contradiction. We conclude that  $G - H$  is a stable set of  $G$ , and since each vertex of  $G - H$  is adjacent to exactly one vertex of  $H$ ,  $G$  is a bloomed  $C_k$  with trivial blooms.  $\square$

We can prove now the main result of this section.

**Theorem 19.** *Let  $G$  be a paw-free graph. Then,  $G$  is a CA graph if and only if  $G$  contains no induced bipartite claw,  $K_{2,3}$ ,  $G_2$ ,  $G_4$ ,  $G_7$ , or  $C_j^*$ , for any  $j \geq 4$ .*

*Proof.* Let  $H$  be a paw-free graph. Suppose, by way of contradiction, that  $H$  is not isomorphic to the bipartite claw,  $K_{2,3}$ ,  $G_2$ ,  $G_4$ ,  $G_7$ , or  $C_j^*$ , for  $j \geq 4$ , but  $H$  is still a minimally non-CA graph. Since  $H$  is paw free,  $H$  is non-basic and, by Corollary 4,  $H$  contains an induced  $C_j$  for some  $j \geq 4$ . By Theorem 17 and Theorem 18,  $H$  is either an augmented multiple of  $\overline{tK_2}$  for some  $t \geq 2$  or a bloomed  $C_j$  with trivial blooms. It is easy to see that a bloomed  $C_j$  with trivial blooms is CA, and an augmented multiple of  $\overline{tK_2}$  is shown to be CA in Theorem 14. In both cases, we get a contradiction.  $\square$

### 2.3.3 Claw-free chordal graphs

A graph is *claw-free chordal* if it contains neither an induced claw nor a hole. Claw-free graphs are widely studied in the literature, see for example [PR76] or recent results in [CS05]. Besides, as *PCA* graphs are claw-free, the study of claw-free chordal graphs arises naturally from the characterization of *PCA* graphs within the class of chordal graphs.

**Lemma 2.** *Let  $G$  be a  $\{\text{claw}, \text{net}^*, G_5, G_6\}$ -free chordal graph that contains a net  $L$  induced by  $\{t_1, t_2, t_3, b_1, b_2, b_3\}$ , where  $\{t_1, t_2, t_3\}$  induces a triangle and  $b_i$  is adjacent to  $t_i$  for  $i = 1, 2, 3$ . If  $v$  is a vertex in  $G - L$ , then  $N_L(v)$  is either  $\{b_i, t_i\}$ , or  $\{t_1, t_2, t_3, b_i\}$  or  $\{b_{i+1}, t_{i+1}, t_{i+2}, b_{i+2}\}$ , for some  $i \in \{1, 2, 3\}$  (indices should be understood modulo 3).*

*Proof.* We will analyze the different cases for  $|N_L(v)|$ . If  $|N_L(v)| = 0$ , then  $L \cup \{v\}$  induces  $\text{net}^*$ , a contradiction. If  $|N_L(v)| = 1$ , then either  $N_L(v) = \{b_i\}$  or  $N_L(v) = \{t_i\}$  for some  $i \in \{1, 2, 3\}$ . In the first case,  $L \cup \{v\}$  induces  $G_5$ ; in the second case,  $b_i, t_i, t_{i+1}, v$  induce a claw. In both cases, we get a contradiction.

If  $|N_L(v)| = 2$ , then the representative cases for  $N_L(v)$  up to symmetry are:  $\{b_i, b_{i+1}\}$ ,  $\{t_i, t_{i+1}\}$ ,  $\{b_i, t_{i+1}\}$ ,  $\{b_i, t_i\}$ . In the first case,  $b_i t_i t_{i+1} b_{i+1} v$  is a hole; in the second and third cases,  $t_{i+1}, t_{i+2}, b_{i+1}, v$  induce a claw. So, if  $|N_L(v)| = 2$ , then  $N_L(v) = \{b_i, t_i\}$  for some  $i \in \{1, 2, 3\}$ . If  $|N_L(v)| = 3$ , then the representative cases up to symmetry are:  $\{b_1, b_2, b_3\}$ ,  $\{b_i, b_{i+1}, t_{i+2}\}$ ,  $\{t_1, t_2, t_3\}$ ,  $\{b_i, b_{i+1}, t_{i+1}\}$ ,  $\{b_i, t_{i+1}, t_{i+2}\}$ ,  $\{b_i, t_i, t_{i+1}\}$ . In the

---



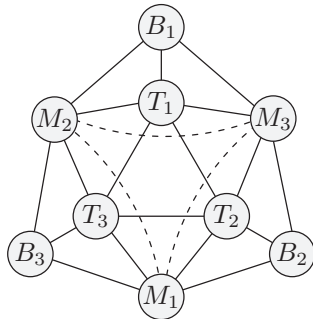

Figure 2.3: Circles represent cliques. Two circles are adjacent, non-adjacent or joined by a dotted line if the corresponding cliques are mutually complete, anticomplete, or not necessarily complete or anticomplete, respectively.

first two cases,  $N_L(v) \cup \{v\}$  induces a claw; in the third case,  $N_L(v) \cup \{v\}$  induces  $G_6$ ; in the fourth and fifth cases,  $b_i t_i t_{i+1} v$  is a hole; in the last case  $t_{i+1}, b_{i+1}, t_{i+2}, v$  induce a claw. In all the cases we get a contradiction.

Finally, if  $v$  is adjacent to  $b_{i+1}, b_{i+2}$  and to either  $b_i$  or  $t_i$ , then either  $\{v, b_{i+1}, b_{i+2}, b_i\}$  or  $\{v, b_{i+1}, b_{i+2}, t_i\}$  induces a claw, respectively. So, if  $|N_L(v)| \geq 4$ , then  $N_L(v)$  is either  $\{t_1, t_2, t_3, b_i\}$  or  $\{b_{i+1}, t_{i+1}, t_{i+2}, b_{i+2}\}$ , for some  $i \in \{1, 2, 3\}$ .  $\square$

**Theorem 20.** *Let  $G$  be a claw-free chordal graph that contains an induced net, and such that all its proper induced subgraphs are CA graphs. Then, exactly one of the following conditions holds:*

1.  $G$  is isomorphic to  $\text{net}^*$ ,  $G_5$  or  $G_6$ .
2.  $G$  is a CA graph.

*Proof.* Assume that  $G$  is not isomorphic to  $\text{net}^*$ ,  $G_5$  or  $G_6$ . Since these graphs are non-CA and all proper induced subgraphs of  $G$  are CA,  $G$  contains no induced  $\text{net}^*$ ,  $G_5$  or  $G_6$ . We claim that  $G$  has as an induced subgraph  $H$  that is a multiple of a net; i.e., the vertices of  $H$  can be partitioned into six non-empty cliques  $B_1, B_2, B_3, T_1, T_2, T_3$  such that  $T_1, T_2, T_3$  are mutually complete and  $T_i$  is complete to  $B_i$  and anticomplete to  $B_{i+1}$  and  $B_{i+2}$ , for each  $i = 1, 2, 3$  (from now on, the indices should be understood modulo 3). Moreover, the vertices of  $G - H$  can be partitioned into three (possibly empty) cliques  $M_1, M_2, M_3$  such that, for each  $i = 1, 2, 3$ ,  $M_i$  is complete to  $B_{i+1}, B_{i+2}, T_{i+1}$  and  $T_{i+2}$  and anticomplete to  $B_i$  and  $T_i$ . A scheme of this situation can be seen in Figure 2.3.

We will prove the claim by induction on the number  $n$  of vertices of  $G$ . Clearly, if  $G$  is a net, then the claim holds. Assume that  $n > 6$  and that

the desired result holds for graphs with less than  $n$  vertices. Since  $n > 6$ , there exists a vertex  $v$  of  $G$  such that  $G' = G - \{v\}$  contains an induced net. By inductive hypothesis, since  $G'$  is claw-free chordal,  $G'$  has an induced subgraph  $H$  that is a multiple of a net and the vertices of  $G' - H$  can be partitioned into three cliques  $M_1, M_2, M_3$  satisfying the conditions above.

Choose  $t_i \in T_i, b_i \in B_i$  for each  $i = 1, 2, 3$  (recall that  $T_i$  and  $B_i$  are non-empty for  $i = 1, 2, 3$ ). Let  $L$  be the subgraph induced by  $\{t_1, t_2, t_3, b_1, b_2, b_3\}$ . By Lemma 2, either  $N_L(v) = \{b_i, t_i\}$ ,  $N_L(v) = \{t_1, t_2, t_3, b_i\}$  or  $N_L(v) = \{b_{i+1}, t_{i+1}, t_{i+2}, b_{i+2}\}$ , for some  $i \in \{1, 2, 3\}$ .

Suppose first that  $N_L(v) = \{t_i, b_i\}$  for some  $i \in \{1, 2, 3\}$ . Let  $j \in \{1, 2, 3\}$ ,  $b'_j \in B_j$ , and  $L'$  be the net induced by  $\{t_1, t_2, t_3, b'_j, b_{j+1}, b_{j+2}\}$ . Applying Lemma 2 to  $L'$ , it follows that  $v$  is adjacent to  $b'_j$  if and only if  $j = i$ . Thus,  $v$  is complete to  $B_i$  and anticomplete to  $B_{i+1}$  and  $B_{i+2}$ . Using the same strategy, we can prove that  $v$  is complete to  $T_i$  and anticomplete to  $T_{i+1}$  and  $T_{i+2}$ . Since  $G$  is claw-free,  $v$  must be complete to  $M_{i+1}$  (if  $w$  were a non-neighbour of  $v$  in  $M_{i+1}$ , then  $t_i, t_{i+1}, w, v$  would induce a claw) and, by symmetry,  $v$  is also complete to  $M_{i+2}$ . Moreover, since  $G$  is  $C_4$ -free,  $v$  is anticomplete to  $M_i$  (if  $w$  were a neighbour of  $v$  in  $M_i$ , then  $t_i, t_{i+1}, w, v$  would induce  $C_4$ ). Thus, the claim holds for  $G$  replacing  $B_i$  by  $B_i \cup \{v\}$ .

Next, suppose that  $N_L(v) = \{t_1, t_2, t_3, b_i\}$  for some  $i \in \{1, 2, 3\}$ . Reasoning as in the first case, it follows that  $v$  is complete to  $T_1, T_2, T_3, B_i$  and anticomplete to  $B_{i+1}$  and  $B_{i+2}$ . Since  $G$  is  $C_4$ -free,  $v$  must be complete to  $M_{i+1}$  (if  $w$  were a non-neighbour of  $v$  in  $M_{i+1}$ , then  $b_i, v, t_{i+2}, w$  would induce a  $C_4$ ) and, by symmetry, also to  $M_{i+2}$ . Since  $G$  is claw-free,  $v$  must be anticomplete to  $M_i$  (if  $w$  were a neighbour of  $v$  in  $M_i$ , then  $w, b_{i+1}, b_{i+2}, v$  would induce a claw). Thus, the claim holds for  $G$  replacing  $T_i$  by  $T_i \cup \{v\}$ .

Finally, suppose that  $N_L(v) = \{b_{i+1}, t_{i+1}, t_{i+2}, b_{i+2}\}$  for some  $i \in \{1, 2, 3\}$ . Reasoning again as in the first case, it follows that  $v$  is complete to  $B_{i+1}, T_{i+1}, T_{i+2}, B_{i+2}$  and anticomplete to  $B_i$  and  $T_i$ . Since  $G$  is claw-free,  $v$  must be complete to  $M_i$  (if  $w$  were a non-neighbour of  $v$  in  $M_i$ , then  $t_i, t_{i+1}, w, v$  would induce a claw). Thus, the claim holds for  $G$  replacing  $M_i$  by  $M_i \cup \{v\}$ . This ends the proof of the claim.

If  $M_i$  and  $M_{i+1}$  are non-empty and  $m_i, m_{i+1}$  are vertices in  $M_i$  and  $M_{i+1}$ , respectively, then either  $m_i t_{i+1} t_i m_{i+1} b_{i+2}$  induce a  $C_5$  or  $m_i t_{i+1} t_i m_{i+1}$  induce a  $C_4$ . Since  $G$  is chordal, at most one of  $\{M_1, M_2, M_3\}$  is non-empty. Consequently,  $G$  is either a multiple of a net (if every  $M_i$  is empty) or a multiple of the graph  $S$  depicted in Figure 2.4. Since the net and  $S$  are easily seen to be a CA graph,  $G$  is also a CA graph.  $\square$

We can now prove the main result of this section.

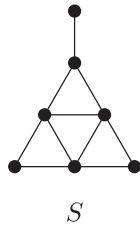
Figure 2.4: The graph  $S$ .

**Theorem 21.** *Let  $G$  be a claw-free chordal graph. Then,  $G$  is  $CA$  if and only if  $G$  contains no induced tent\*, net\*,  $G_5$  or  $G_6$ .*

*Proof.* Let  $H$  be a claw-free chordal graph. Suppose, by way of contradiction, that  $H$  is not isomorphic to tent\*, net\*,  $G_5$  or  $G_6$ , but  $H$  is still a minimally non- $CA$  graph. Since  $H$  is claw-free and chordal,  $H$  is non-basic and, by Corollary 4,  $H$  contains an induced net or tent. If  $H$  contains an induced net, then by Theorem 20,  $H$  is isomorphic to a net\*,  $G_5$  or  $G_6$ , a contradiction. Thus,  $H$  contains no induced net but an induced tent. Since  $H$  is non-basic, it is connected (Corollary 3). So, by Theorem 11,  $H$  is a multiple of a tent and, in particular, a  $CA$  graph, a contradiction.  $\square$

#### 2.3.4 Diamond-free graphs

A *diamond-free* graph is a graph with no induced diamond. Diamond-free graphs have been extensively studied. (See, for example, [CY81, Con89, Tuc87].)

**Theorem 22.** *Let  $G$  be a diamond-free graph that contains a hole, and such that all its proper induced subgraphs are  $CA$  graphs. Then, exactly one of the following conditions holds:*

1.  $G$  is isomorphic to  $K_{2,3}$ ,  $G_2$ ,  $G_3$ ,  $G_4$ ,  $G_7$ ,  $\overline{C_6}$ ,  $G_9$ , or  $C_j^*$  for some  $j \geq 4$ .
2.  $G$  is a  $CA$  graph. More precisely, if  $H$  is any induced hole of  $G$ , and  $V(H) = \{h_1, \dots, h_k\}$  where  $h_i$  is adjacent to  $h_{i+1}$  for each  $i = 1, \dots, k$  (indices should be understood modulo  $k$ ), then the vertices of  $G - H$  can be partitioned into  $k + 1$  (possibly empty) pairwise anticomplete sets  $U_1, \dots, U_k, S$  such that the following conditions hold:
  - For each  $i = 1, \dots, k$ ,  $G[U_i]$  is the union of vertex-disjoint cliques and for each  $u \in U_i$ ,  $N_H(u) = \{h_i\}$ .

- For each  $s \in S$  there is an integer  $i$ ,  $1 \leq i \leq k$ , such that  $N_H(s) = \{h_i, h_{i+1}\}$ ; in addition, if  $s_1, s_2 \in S$ , then  $s_1$  and  $s_2$  are adjacent if and only if  $N_H(s_1) = N_H(s_2)$ .

*Proof.* Assume that  $G$  is not isomorphic to  $K_{2,3}$ ,  $G_2$ ,  $G_3$ ,  $G_4$ ,  $G_7$ ,  $\overline{C_6}$ ,  $G_9$ , or  $C_j^*$  for any  $j \geq 4$ . Since all of these graphs are non- $CA$  and all proper induced subgraphs of  $G$  are  $CA$ ,  $G$  contains none of these graphs as induced subgraphs.

Let  $H$  be an induced hole on  $G$  of length  $k$  and let  $v$  be any vertex of  $G - H$ . Since  $G$  is not isomorphic to  $K_{2,3}$ ,  $G_2$ ,  $G_3$ ,  $G_4$ , or  $C_j^*$ , for any  $j \geq 4$ , by Theorem 13, either  $v$  is complete to  $H$  or  $N_H(v)$  induces a non-empty path in  $H$ . Since  $G$  is diamond-free,  $v$  is adjacent to at most two vertices of  $H$ . So, each vertex of  $G - H$  is adjacent to either a single vertex or two adjacent vertices of  $H$ .

Let  $V(H) = \{h_1, \dots, h_k\}$ , where  $h_i$  is adjacent to  $h_{i+1}$  for each  $i = 1, \dots, k$  (from now on, indices should be understood modulo  $k$ ). Let  $U_i$  be the set of vertices  $v$  of  $G - H$  with  $N_H(v) = \{h_i\}$ . Since  $h_i$  is adjacent to all vertices of  $U_i$  and  $G$  is diamond-free,  $G[U_i]$  contains no induced  $P_3$  and therefore  $G[U_i]$  is the union of vertex disjoint cliques.

We now show that if  $i \neq j$ , then  $U_i$  is anticomplete to  $U_j$ . Suppose, by way of contradiction, that there exist  $i$  and  $j$ ,  $i \neq j$ , such that some vertex  $u_i \in U_i$  is adjacent to some vertex  $u_j \in U_j$ . Let  $P^1$  and  $P^2$  be the two distinct paths on  $H$  joining  $h_i$  and  $h_j$ . If  $P^1$  has more than four vertices, then there is an interior vertex  $w$  of  $P^1$  that is anticomplete to  $P^2$ , so  $\{u_i, u_j\} \cup V(P^2) \cup \{w\}$  induces on  $G$  a graph isomorphic to  $C_m^*$  for some  $m \geq 4$ , a contradiction. Thus, each one of  $P^1$  and  $P^2$  has at most four vertices. Without loss of generality, we may assume that  $|P^1| \leq |P^2|$ . If  $|P^1| = 2$  and  $|P^2| = 4$ , then  $\{u_i, u_j\} \cup V(H)$  induces  $G_7$ ; if  $|P^1| = 3$  and  $|P^2| = 3$ , then  $\{u_i, u_j\} \cup V(H)$  induces  $G_2$ ; if  $|P^1| = 3$  and  $|P^2| = 4$ , then  $\{u_i, u_j\} \cup V(H)$  induces  $G_4$ ; if  $|P^1| = 4$  and  $|P^2| = 4$ , then  $\{u_i, u_j\} \cup (V(H) - \{h_i\})$  induces a bipartite claw. In all the cases, we get a contradiction. We conclude that if  $i \neq j$ , then  $U_i$  is anticomplete to  $U_j$ .

Let  $S$  be the set of vertices  $v$  of  $G - H$  that are adjacent to two vertices of  $H$ . Let  $s_1, s_2$  be two vertices of  $S$ ,  $i$  and  $j$  be such that  $N_H(s_1) = \{h_i, h_{i+1}\}$  and  $N_H(s_2) = \{h_j, h_{j+1}\}$ . Since  $G$  is diamond-free, if  $i = j$ , then  $s_1$  and  $s_2$  must be adjacent and if  $|i - j| = 1$ , then  $s_1$  and  $s_2$  must be non-adjacent. Suppose now that  $|i - j| > 1$ , so  $h_i, h_{i+1}, h_j$  and  $h_{j+1}$  are pairwise distinct. Assume for contradiction that  $s_1$  and  $s_2$  are adjacent. Let  $P^1$  be the path on  $H$  whose vertices are  $\{h_{i+1}, h_{i+2}, \dots, h_j\}$  and  $P^2$  be the path on  $H$  whose vertices are  $\{h_{j+1}, h_{j+2}, \dots, h_i\}$ . If  $P^1$  and  $P^2$  have no internal vertices, then  $\{s_1, s_2\} \cup V(H)$  induces  $\overline{C_6}$ , a contradiction. We can assume, without loss of generality, that  $P^1$  has at least one internal vertex  $w$ . But, then

---

$w$  is anticomplete to the hole induced on  $G$  by  $\{s_1, s_2\} \cup V(P^2)$ , hence  $\{s_1, s_2, w\} \cup V(P^2)$  induces on  $G$  a graph isomorphic to  $C_m^*$  for some  $m \geq 4$ , a contradiction. So,  $s_1$  and  $s_2$  are non-adjacent.

Now we will prove that  $U_i$  is anticomplete to  $S$  for each  $i = 1, \dots, k$ . Suppose, by way of contradiction, that there exist adjacent vertices  $u_i \in U_i$  and  $s \in S$ , and let  $j$  be such that  $N_H(s) = \{h_j, h_{j+1}\}$ . Since  $G$  is diamond-free,  $i$  is different from  $j$  and  $j + 1$ . Let  $P^1$  be the path on  $H$  whose vertices are  $\{h_i, h_{i+1}, \dots, h_j\}$  and  $P^2$  the path on  $H$  whose vertices are  $\{h_{j+1}, \dots, h_{i-1}, h_i\}$ . If  $P^2$  has more than three vertices, then  $h_{j+2}$  is anticomplete to the hole induced by  $\{s, u_i\} \cup V(P^1)$ , a contradiction. Analogously,  $P^1$  has at most three vertices. If  $|P^1| = 2$  and  $|P^2| = 3$ , then  $\{u_i, s\} \cup V(H)$  induces  $G_3$ ; if  $|P^1| = 3$  and  $|P^2| = 3$ , then  $\{u_i, s\} \cup V(H)$  induces  $G_9$ . We may assume  $|P_1| \leq |P_2|$ . In both cases, we have a contradiction. We conclude that  $U_i$  is anticomplete to  $S$  for each  $i = 1, \dots, k$ .

Finally, it is not difficult to see that a graph satisfying these conditions is a  $CA$  graph. This concludes the proof.  $\square$

**Theorem 23.** *Let  $G$  be a diamond-free chordal graph that contains an induced net, and such that all its proper induced subgraphs are  $CA$  graphs. Then, exactly one of the following conditions holds:*

1.  $G$  is isomorphic to a net\*,  $G_5$ , or  $G_6$ .
2.  $G$  is a fully bloomed triangle, and in consequence, it is a  $CA$  graph.

*Proof.* Assume that  $G$  is not isomorphic to net\*,  $G_5$ , or  $G_6$ . Since all of these graphs are non- $CA$  and all proper induced subgraphs of  $G$  are  $CA$ ,  $G$  contains none of these graphs as induced subgraphs.

We will show that  $G$  is a fully bloomed triangle, and, as a consequence, a  $CA$  graph. We will argue by induction on the number of vertices of  $G$ .

Clearly, a net is a fully bloomed triangle. Suppose that  $G$  has  $n > 6$  vertices and that the result holds for graphs with  $n - 1$  vertices. Since  $G$  has more than six vertices, there exists a vertex  $v$  of  $G$  such that  $G - \{v\}$  contains an induced net.

Moreover,  $G - \{v\}$  is diamond-free chordal, all its proper induced subgraphs are  $CA$  graphs and it is not isomorphic to net\*,  $G_5$ , or  $G_6$ . So, by inductive hypothesis,  $G - \{v\}$  is a fully bloomed triangle. That is, there exists a triangle  $T$  of  $G - \{v\}$  such that the remaining vertices of  $G - \{v\}$  induce a disjoint union of complete graphs  $M_1, M_2, \dots, M_m$ , where each  $M_i$  is complete to one vertex of  $T$  and anticomplete to the others, and each vertex of  $T$  is complete to at least one of  $M_1, M_2, \dots, M_m$ . The vertex  $v$  is

adjacent to at least one vertex of  $G - \{v\}$  because  $G$  contains no induced  $\text{net}^*$ . On the other hand, since  $G$  is chordal and diamond-free and  $G - \{v\}$  is connected,  $N(v)$  induces a complete graph on  $G$ . So, either  $N(v) \subseteq T$  or  $N(v) \subseteq M_i \cup \{t\}$ , where  $t \in T$  and  $M_i$  is a bloom complete to  $t$ . In the first case, since  $G$  contains no induced  $G_6$ ,  $|N(v)| \neq 3$ , and since  $G$  is diamond free,  $|N(v)| \neq 2$ . Therefore,  $N(v) = \{t\}$  for some  $t \in T$  and  $\{v\}$  is a new bloom complete to  $t$ . In the second case, since  $G$  is diamond-free, either  $|N(v)| = 1$  or  $N(v) = M_i \cup \{t\}$ . If  $N(v) = \{t\}$  with  $t \in T$ , then  $\{v\}$  is a new bloom for  $t$ ; if  $N(v) = \{w\}$  with  $w \in M_i$ , then  $G$  contains an induced  $G_5$ , a contradiction; if  $N(v) = M_i \cup \{t\}$ , then  $G$  is a fully bloomed triangle replacing  $M_i$  by  $M_i \cup \{v\}$ .  $\square$

Finally, we can prove the main result of this section.

**Corollary 5.** *A diamond-free graph  $G$  is CA if and only if  $G$  contains no induced bipartite claw,  $\text{net}^*$ ,  $K_{2,3}$ ,  $G_2$ ,  $G_3$ ,  $G_4$ ,  $G_5$ ,  $G_6$ ,  $G_7$ ,  $\overline{C_6}$ ,  $G_9$ , or  $C_j^*$ , for any  $j \geq 4$ .*

*Proof.* Let  $H$  be a diamond-free graph. Suppose, by way of contradiction, that  $H$  is not isomorphic to the bipartite claw,  $\text{net}^*$ ,  $K_{2,3}$ ,  $G_2$ ,  $G_3$ ,  $G_4$ ,  $G_5$ ,  $G_6$ ,  $G_7$ ,  $\overline{C_6}$ ,  $G_9$ , or  $C_j^*$ , for any  $j \geq 4$ , but  $H$  is still a minimally non-CA graph. Since  $H$  is not an interval graph but it does not contain a bipartite claw and it is diamond-free, by Theorem 2,  $H$  contains either a hole or an induced net. If  $H$  contains a hole,  $H$  contradicts Theorem 22. Otherwise,  $H$  is chordal. Then,  $H$  contains an induced net, and so  $H$  contradicts Theorem 23.  $\square$

## 2.4 Summary and further results

The partial characterizations of circular-arc graphs by forbidden induced subgraphs obtained in this thesis are summarized in Table 2.1.

Graph classes	Minimal forbidden induced subgraphs	Reference
$P_4$ -free graphs	$K_{2,3}$ , $C_4^*$	§ 2.3.1
Paw-free graphs	bipartite claw, $K_{2,3}$ , $G_2$ , $G_4$ , $G_7$ , $C_j^*$ ( $j \geq 4$ )	§ 2.3.2
Claw-free chordal graphs	$\text{tent}^*$ , $\text{net}^*$ , $G_5$ , $G_6$	§ 2.3.3
Diamond-free graphs	bipartite claw, $\text{net}^*$ , $K_{2,3}$ , $G_2$ , $G_3$ , $G_4$ , $G_5$ , $G_6$ , $G_7$ , $\overline{C_6}$ , $G_9$ , $C_j^*$ ( $j \geq 4$ )	§ 2.3.4

Table 2.1: Minimal forbidden induced subgraphs for circular-arc graphs in each studied class.

A CA graph is a *normal circular-arc (NCA)* graph if it admits a circular-arc model such that no two arcs cover the whole circle. For example, interval graphs and semi-circular graphs are NCA graphs. An example

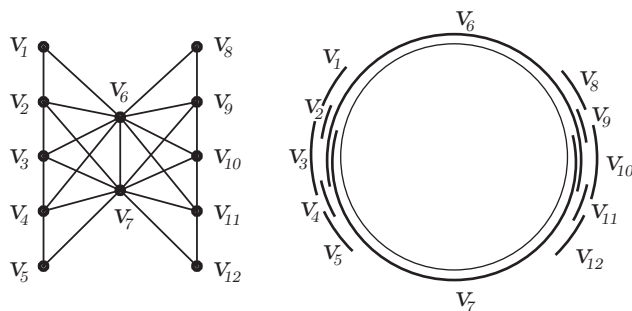

Figure 2.5: Minimally non- $NCA$  graph that is  $CA$ , and its circular-arc model.

of a graph which is not  $NCA$  is given in Figure 2.5. This concept was studied in [DGM<sup>+</sup>06, Gol04, HH04], but the terminology  $NCA$  was introduced in [LS06b]. The characterization of non- $NCA$  graphs by minimal forbidden induced subgraphs is not known. The proofs in this paper show that, for the classes analyzed here, all  $CA$  graphs are also  $NCA$ . So, the characterizations obtained for  $CA$  graphs also hold for  $NCA$  graphs. Moreover, we can state the following result.

**Corollary 6.** *If  $H$  is a minimally non- $NCA$  graph and  $H$  is a  $CA$  graph, then  $H$  contains an induced diamond, an induced  $P_4$ , an induced paw, and either an induced claw or a hole.*





## Chapter 3

# Circle graphs

### 3.1 Introduction

A graph  $G = (V, E)$  is a *circle graph* if there exists a one-to-one function  $f : V \rightarrow L$  ( $f(v) = C_v$ ) where  $L = \{C_v\}_{v \in V(G)}$  is a family of chords on a circle, whose extremes are all different, such that  $uv \in E$  if and only if  $u \neq v$  and  $C_u \cap C_v \neq \emptyset$ .  $L$  is called a *circle model* of  $G$ . A graph  $G = (V, E)$  is *overlap interval* if there exists a bijective function  $f : V \rightarrow I$  ( $f(v) = I_v$ ) where  $I = \{I_v\}_{I \in V(G)}$  is a family of intervals on the real line, such that  $uv \in E$  if and only if  $I_u$  and  $I_v$  overlap; i.e.,  $I_u \cap I_v \neq \emptyset$ ,  $I_u \not\subseteq I_v$  and  $I_v \not\subseteq I_u$ . It is well-known that circle graphs and overlap interval graphs are the same class, see for instance [Gol04].

Circle graphs were introduced by Even and Itai in [EI71] to solve a problem of parallel stacks without the restriction of loading before unloading is completed. In addition, the problem under this restriction is faced in the same article. A stack is a linear storage device which has only one orifice. The problem consist in finding the minimum number  $m$  of stacks necessary to transfer a set of items  $\{1, \dots, n\}$  stored in  $A$ , whose order is given by a permutation  $P$  of  $\{1, \dots, n\}$ , by using a set of parallel stacks  $S_1, \dots, S_m$  which can be unloaded to load a stack  $B$  before the stack  $A$  is completely unloaded ( $P^{-1}(i)$  stands for the position in which the item  $i$  is placed in  $A$ ). Even and Itai proved that this problem can be translated into the problem of finding the chromatic number of a circle graph. Unfortunately, this problem turns out to be NP-complete [GJMP80].

Naji [Naj85] characterized circle graphs in terms of the solvability of a system of linear equations, yielding a polynomial-time recognition algorithm for this class. Then, Gasses gave a shorter proof of Naji's characterization in [Gas97] by using a Bouchet's theorem.

Different polynomial-time recognition algorithms for circle graphs were presented in the literature. These algorithms are strongly based on the

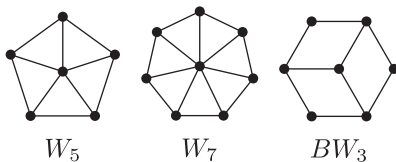
Figure 3.1: Graphs  $W_5$ ,  $W_7$  and  $BW_3$ 

notion of split decomposition. The best one has a quadratic time complexity and is due to Spinrad [Spi94].

The *local complement* of a graph  $G$  with respect to a vertex  $u \in V(G)$  is the graph  $G * u$  that arises from  $G$  by replacing the induced subgraph  $G[N_G(u)]$  by its complement. Two graphs  $G$  and  $H$  are *locally equivalent* if and only if  $G$  arises from  $H$  by a finite sequence of local complementations. It is easy to see that being locally equivalent is an equivalence relation and thus any class of graphs can be partitioned into equivalence classes under this equivalence relation. A class of graphs is said to be *closed by local complementation* if and only if given any graph  $G$  in the class implies that any graph belonging to the same class of equivalence also belongs to the class.

**Theorem 24.** [Bou94] *The class of circle graphs is closed by local complementations.*

Moreover, Bouchet gave the following characterization of circle graphs in terms of forbidden induced subgraphs and local equivalence.

**Theorem 25.** [Bou94] *Let  $G$  be a graph. Then,  $G$  is a circle graph if and only if no graph locally equivalent to  $G$  contains  $W_5$ ,  $W_7$ , or  $BW_3$  as induced subgraph (see Figure 3.1).*

We would like to remark which is the most important disadvantage of the characterization above respect to a classical characterization by means of a list of forbidden induced subgraphs. Whereas in the classical characterization containing none of the graphs of a possibly infinite list of induced subgraphs implies that the graph belongs to the class, in the characterization of Theorem 25 we have to check that any graph belonging to the class of equivalence of the given graph contains none of the three prescribed graphs of the list as induced subgraph.

Geelen and Oum [GO09] gave a new characterization of circle graphs in terms of pivoting. The result of pivoting a graph  $G$  with respect to an edge  $uv$  is the graph  $G \times uv = G * u * v * u$  (where  $*$  stands for local complementation). A graph  $G'$  is *pivot-equivalent* to  $G$  if  $G'$  arises from  $G$  by a sequence of pivoting operations. They proved, with the aid of a

computer, that  $G$  is a circle graph if and only if each graph that is pivot-equivalent to  $G$  contains none of 15 prescribed induced subgraphs.

In [CDG02] a superclass of circle graphs (denoted as Bouchet graphs) is defined. A graph  $G$  is Bouchet if and only if no induced subgraph of  $G$  is locally equivalent to  $W_5$ ,  $W_7$ , or  $BW_3$ . The list of 33 minimal forbidden induced subgraphs for this class is obtained using a computer, closing under local complementation the graphs  $W_5$ ,  $W_7$  and  $BW_3$ . Clearly, the graphs of this family are also minimal forbidden subgraphs for circle graphs, however, this list is not enough to characterize circle graphs completely. In the same work it is shown that circle graphs are a proper subclass of Bouchet graphs.

In spite of the mentioned works, there are not known characterizations of circle graphs only by forbidden induced subgraphs; i.e., not involving additionally the notions of local equivalence or pivoting operations. In this thesis, we present some results in this direction, providing forbidden induced subgraphs characterizations of circle graphs within different graph classes. These results appear in [BDGS].

Let  $G_1$  and  $G_2$  be two graphs such that  $|V(G_i)| \geq 3$ , for each  $i = 1, 2$ , and assume that  $V(G_1) \cap V(G_2) = \emptyset$ . Let  $v_i$  be a distinguished vertex of  $G_i$ , for each  $i = 1, 2$ . The *split composition* of  $G_1$  and  $G_2$  with respect to  $v_1$  and  $v_2$  is the graph  $G_1 * G_2$  whose vertex set is  $V(G_1 * G_2) = (V(G_1) \cup V(G_2)) \setminus \{v_1, v_2\}$  and whose edge set is  $E(G_1 * G_2) = E(G_1 - \{v_1\}) \cup E(G_2 - \{v_2\}) \cup \{uv : u \in N_{G_1}(v_1) \text{ and } v \in N_{G_2}(v_2)\}$ . The vertices  $v_1$  and  $v_2$  are called the *marker vertices*. We say that  $G$  has a *split decomposition* if there exist two graphs  $G_1$  and  $G_2$  with  $|V(G_i)| \geq 3$ ,  $i = 1, 2$ , such that  $G = G_1 * G_2$  with respect to some pair of marker vertices. If so,  $G_1$  and  $G_2$  are called the *factors* of the split decomposition. Notice that  $G_1$  and  $G_2$  are induced subgraphs of  $G$ . Those graphs that do not have a split decomposition are called *prime graphs*. It is worth pointing out that those prime circle graphs have a unique circle model up to reflections. Notice that if any of the factors of a split decomposition admits a split decomposition we can continue the process until every factor is prime, a star or a complete. The resulting decomposition into prime graphs, stars and completes might not be unique. Nevertheless, in [Cun82] it is proved that if the number of factors is minimum then the decomposition is unique (up to reordering of the factors). The connection between circle graphs and split decomposition was discovered by Bouchet [Bou87] who proved that circle graphs are closed under split composition.

**Theorem 26.** [Bou87] *Let  $G$  be a graph that has a split decomposition  $G = G_1 * G_2$ . Then,  $G$  is a circle graph if and only if both  $G_1$  and  $G_2$  are circle graphs.*

As a consequence of Theorem 24, we can prove the following result.

**Theorem 27.** *Let  $G$  be a graph. If  $G$  is not a circle graph, then any graph  $H$  that arises from  $G$  by edge subdivisions is not a circle graph.*

*Proof.* Suppose that  $H$  arises from  $G$  by edge subdivisions. So,  $H$  is obtained from  $G$  by replacing some edges  $\{u_1w_1, \dots, u_rw_r\}$  of  $G$  by induced paths  $\{P_1, \dots, P_r\}$  of length at least two. On the one hand, since  $u_iw_i$  was replaced by an induced path  $P = u = v_1, \dots, v_k = w$  with  $k \geq 3$ . It is easy to see that if local complementation is applied successively in the interior vertices of  $P_i = u_i = v_1^i, v_2^i, \dots, v_{k_i}^i = w_i$  from  $v_2^i$  to  $v_{k_i-1}^i$ ,  $u$  and  $w$  are adjacent in the resulting graph. Applying this procedure for each  $i = 1, \dots, k$  we clearly obtain a graph  $H'$  which contains  $G$  as induced subgraph and belongs to the same class of equivalence as  $H$ . Since  $G$  is not a circle graph and the class is hereditary,  $H'$  is not a circle graph. Hence, by Theorem 24,  $H$  is not a circle graph.  $\square$

The remaining sections of this chapter are organized as follows. In Section 3.2 we characterize circle graphs within linear domino graphs by using split decomposition. In Section 3.3, the same task is done within two superclasses of cographs (namely,  $P_4$ -tidy graphs and tree-cographs), by using the forbidden induced subgraphs characterization of permutation graphs. Finally, in the last Section, we introduce and completely characterize by minimal forbidden induced subgraphs the class of *unit Helly circle graphs*.

## 3.2 Linear domino graphs

In this section we will characterize circle graphs by minimal forbidden induced subgraphs within the class of linear domino graphs, using a constructive way (cf. Subsection 1.2.1).

The graph  $\overline{C_6}$  is a prism where each triangle is linked by induced path  $P_1, P_2$  and  $P_3$  having just one edge each. This graph is locally equivalent to  $W_5$ , so by Theorem 25,  $\overline{C_6}$  is not a circle graph. Besides, since every prism arises from  $\overline{C_6}$  by edge subdivision, Theorem 27 implies that prisms are not circle graphs.

The following theorem characterizes those linear domino graphs that are circle graphs.

**Theorem 28.** *Let  $G$  be a linear domino graph. Then,  $G$  is a circle graph if and only if  $G$  contains no induced prisms.*

*Proof.* The “only if” part follows immediately from Theorem 27 and the fact that the class of circle graphs is hereditary. Suppose now that  $G$  is a linear domino graph not containing induced prisms. We shall prove that  $G$  is a circle graph. Consider the factors of a split decomposition of  $G$  into prime graphs, stars and completes. It is easy to see that stars and

completes are circle graphs. Therefore, by Theorem 26, we may suppose that  $G$  is a prime graph. Since a graph is a circle graph if and only if each of its connected components is a circle graph, we can assume also that  $G$  is connected. Since trees are circle graphs, we can suppose that  $G$  contains at least one chordless cycle. Consider a chordless cycle of  $G$  of maximum length, say  $C = v_1v_2 \dots v_nv_1$ , and let  $X \subseteq V(G)$  be the set of all the vertices having at least one neighbor in  $C$ . We will prove that actually  $V(C) \cup X = V(G)$  and that  $G$  is a circle graph. We will split the proof into three cases:  $n = 3$ ,  $n = 4$  or  $5$ , and  $n \geq 6$ . (From now on, all the operations between indexes should be understood modulo  $n$ .)

*Case 1:  $n = 3$ .* In this case we will prove that  $G$  is isomorphic to  $C$ . Suppose by the way of contradiction that  $G$  is not isomorphic to  $C$  and thus, since  $G$  is connected,  $X \neq \emptyset$ . If  $v$  is a vertex in  $X$ , it necessarily has either one or three neighbors on  $C$ , otherwise  $G$  would contain an induced diamond. Besides, if  $v, w \in X$  with  $|N_C(v)| = 1$  (say  $N_C(v) = \{v_1\}$ ) and  $|N_C(w)| = 3$ , then they are not adjacent. Because, if they were adjacent, then  $v, w, v_1, v_2$  would induce a diamond in  $G$ . On one hand, if  $v, w \in X$  and  $|N_C(v)| = |N_C(w)| = 1$ , then they are adjacent if and only if  $N_C(v) = N_C(w)$ . Indeed, if  $N_C(v) = N_C(w) = \{v_i\}$  and  $v$  and  $w$  were not adjacent, then the vertices  $v, w, v_i, v_{i+1}$  would induce a claw, a contradiction. Conversely, if  $N_C(v) = \{v_i\}$ ,  $N_C(w) = \{v_{i+1}\}$  and  $vw \in E(G)$ , the set of vertices  $\{v, w, v_i, v_{i+1}\}$  would induce a  $C_4$ . This is a contradiction, because we are assuming that  $C$  is a chordless cycle of maximum length. On the other hand, if  $v, w \in X$  and  $|N_C(v)| = |N_C(w)| = 3$ , then  $v$  and  $w$  are adjacent because otherwise  $v, w, v_1, v_2$  would induce a diamond. As a consequence of these observations, it follows that  $X = Q_1 \cup Q_2 \cup Q_3 \cup Q$  where  $Q_1, Q_2, Q_3, Q$  are completes,  $Q_i$  is complete to  $v_i$  and anticomplete to  $V(C) \setminus \{v_i\}$  for every  $i = 1, 2, 3$ ,  $Q$  is complete to  $V(C)$ , and  $Q_1, Q_2, Q_3, Q$  are pairwise anticomplete. We will prove that  $Q_1, Q_2, Q_3, Q$  (when they are non-empty) belong to different connected components of  $G - V(C)$  because of the maximality of  $C$ . By the way of contradiction, let  $P$  be a path in  $G - V(C)$  of minimum length joining two vertices of  $X$  that belong to different sets of the partition  $X = Q_1 \cup Q_2 \cup Q_3 \cup Q$ . By construction,  $P$  has length at least 2 and has no internal vertex in  $V(C) \cup X$ . By symmetry, we just have to consider two cases: the extremes of  $P$  are either  $w_i \in Q_i$  and  $w_j \in Q_j$  with  $i \neq j$ , or  $w_i \in Q_i$  and  $w \in Q$ . In the former case,  $V(P) \cup \{v_i, v_j\}$  would induce a chordless cycle of length at least five. In the latter case,  $V(P) \cup \{v_i\}$  would induce a chordless cycle of length at least four. Both contradictions prove that indeed  $Q_1, Q_2, Q_3, Q$  (if non-empty) belong to different connected components of  $G - V(C)$  that will be denote by  $R_1, R_2, R_3, R$ , respectively. Since  $G$  is a prime graph,  $Q_i = \emptyset$  for all  $i = 1, 2, 3$ . Otherwise,  $V(R_i) \cup \{v_i, v_{i+1}\}$  and  $V(G) \setminus V(R_i)$  form a split decomposition of  $G$ , with  $v_{i+1}$  and  $v_i$  as marker vertices, respectively. For

a similar reason,  $Q = \emptyset$ . Thus,  $V(G) = \{v_1, v_2, v_3\}$  and  $G$  is clearly a circle graph.

*Case 2:  $n = 4$  or  $5$ .* Since  $G$  is a linear domino graph,  $|N_C(v)| = 2$  for every vertex  $v$  belonging to  $X$  and the two neighbors are consecutive in  $C$ . We will prove that if  $v, w \in X$ , then  $vw \in E(G)$  if and only if  $N_C(v) = N_C(w)$ . Suppose that  $N_C(v) \neq N_C(w)$ . On one hand, if  $N_C(v) \cap N_C(w) = \{z\}$  and  $vw \in E(G)$ , then  $G[\{v, w, y, z\}]$  would be isomorphic to a diamond for each  $y \in (N_C(v) \cup N_C(w)) \setminus \{z\}$ , contradiction. On the other hand, if  $N_C(v) \cap N_C(w) = \emptyset$  and  $vw \in E(G)$ , then  $C \cup \{v, w\}$  would induce a prism in  $G$ , another contradiction. So, if  $N_C(v) \neq N_C(w)$ , then  $v$  and  $w$  are nonadjacent. Finally, if  $N_C(v) = N_C(w) = \{y, z\}$ , then  $v$  and  $w$  are adjacent, otherwise  $\{v, w, y, z\}$  would induce a diamond, a contradiction. Hence  $X = Q_1 \cup \dots \cup Q_n$ , where each  $Q_i$  is a complete and  $N_C(x) = \{v_i, v_{i+1}\}$  for every  $x \in Q_i$ . We will prove that the non-empty  $Q_i$ 's belong to a different connected component of  $G - V(C)$ . By the way of contradiction, consider path  $P$  in  $G - V(C)$  of minimum length joining two vertices  $w_i \in Q_i$  and  $w_j \in Q_j$  with  $i \neq j$ . By symmetry, we just have to consider two cases:  $j = i + 1$  and  $j = i + 2$ . By construction,  $P$  has at least two edges and has no internal vertex in  $V(C) \cup X$ . In the first case,  $V(P) \cup (V(C) \setminus \{v_{i+1}\})$  induces a cycle of length strictly greater than  $n$ . In the second case,  $V(P) \cup V(C)$  induces a prism whose triangles are  $\{w_i, v_i, v_{i+1}\}$  and  $\{w_{i+2}, v_{i+2}, v_{i+3}\}$ . Both contradictions prove that indeed each non-empty  $Q_i$  belongs to a different connected component  $R_i$  of  $G - V(C)$ . Since  $G$  is prime, it follows that if  $Q_i$  is non-empty then  $|V(R_i)| = 1$ . Otherwise, let  $w_i \in Q_i$ . Then,  $V(R_i) \cup \{v_i\}$  and  $(V(G) \setminus V(R_i)) \cup \{w_i\}$  would be a split decomposition of  $G$ , with  $v_i$  and  $w_i$  as marker vertices, respectively.

So,  $G$  consists of  $C$  and a (possibly empty) stable set  $X$  with at most one vertex  $w_i$  for each  $1 = 1, \dots, n$ , whose only neighbors in  $G$  are  $v_i$  and  $v_{i+1}$ . It is easy to build a circle model for  $G$ .

*Case 3:  $n \geq 6$ .* First, notice that, since  $G$  is a linear domino graph, every vertex  $v \in X$  satisfies either  $N_C(v) = \{v_i, v_{i+1}\}$  or  $N_C(v) = \{v_i, v_{i+1}, v_{i+k}, v_{i+k+1}\}$  with  $3 \leq k \leq n - 3$ . We will call the first kind of vertices 2-vertices and the second kind of vertices 4-vertices. It can be easily proved, as above, that if  $v$  and  $w$  are 2-vertices, then  $v$  and  $w$  are adjacent if and only if  $N_C(v) = N_C(w)$ . Let us see that if  $v \in X$  is a 2-vertex and  $w \in X$  is a 4-vertex, then  $v$  is adjacent to  $w$  if and only if  $N_C(v) \subseteq N_C(w)$ . Let  $N_C(w) = \{v_i, v_{i+1}, v_{i+k}, v_{i+k+1}\}$ . Suppose first that  $vw \in E(G)$ . Since  $w$  is not the center of a claw,  $v$  should be adjacent to at least one vertex of each pair of nonadjacent neighbors of  $w$ . Besides, since  $N_C(v)$  consists of two consecutive vertices of  $C$ , they should be either  $\{v_i, v_{i+1}\}$  or  $\{v_{i+k}, v_{i+k+1}\}$ . Conversely, suppose that  $N_C(v) \subseteq N_C(w)$ . Again, since  $N_C(v)$  consists of two consecutive vertices of  $C$ , then  $N_C(v)$  should be either  $\{v_i, v_{i+1}\}$  or  $\{v_{i+k}, v_{i+k+1}\}$ . Since  $G$  is diamond-free,  $v$  and  $w$  must be adjacent.

Let  $v$  and  $w$  be two 4-vertices. We assert that  $|N_C(v) \cap N_C(w)| \in \{0, 1, 2\}$  and that  $vw \in E(G)$  if and only if  $N_C(v) \cap N_C(w)$  consists of two consecutive vertices of  $C$ . If  $N_C(v) \cap N_C(w)$  contains two nonadjacent vertices  $x$  and  $y$ , then  $v$  and  $w$  should be nonadjacent, otherwise  $\{x, y, v, w\}$  would induce a diamond in  $G$ . On the other hand, if  $N_C(v) \cap N_C(w)$  contains two adjacent vertices  $x$  and  $y$ , then  $v$  and  $w$  should be adjacent, otherwise  $\{x, y, v, w\}$  would induce a diamond in  $G$ . Therefore,  $v$  and  $w$  can share neither three nor four neighbors, and the “if” of the second part of our assertion holds. Conversely, suppose  $vw \in E(G)$ . Since  $w$  is not the center of a claw,  $v$  should be adjacent to at least one vertex of any pair of nonadjacent neighbors of  $w$ , so  $N_C(v) \cap N_C(w)$  contains two adjacent vertices. If  $N_C(v) \cap N_C(w)$  contained two nonadjacent vertices  $x$  and  $y$ , then  $\{x, y, v, w\}$  would induce a diamond in  $G$ , so  $N_C(v) \cap N_C(w)$  consists exactly of two consecutive vertices of  $C$ .

Therefore,  $X$  is a disjoint union of the sets of vertices  $Q_1, \dots, Q_n, Q$ , where the vertices in  $Q$  are the 4-vertices and the vertices in  $Q_1 \cup \dots \cup Q_n$  are the 2-vertices such that  $N_C(x) = \{v_i, v_{i+1}\}$  for each  $x \in Q_i$ . Each  $Q_i$  is a complete and anticomplete to  $Q_j$  if  $i \neq j$ . Since two 4-vertices share at most two neighbors in  $C$ , in particular there are no two vertices in  $Q$  with the same neighbors in  $C$ . Therefore, the set  $Q$  is a subset of  $\{q_{i,j} : 1 \leq i < j \leq n, i+3 \leq j \leq n+i-3\}$ , where  $N_C(q_{i,j}) = \{v_i, v_{i+1}, v_j, v_{j+1}\}$ ,  $q_{i,j}$  is complete to  $Q_i$  and  $Q_j$  and anticomplete to  $Q_k$  for  $k \neq i, j$ , and  $q_{i,j}q_{i',j'} \in E(G)$  if and only if  $|\{i, j\} \cap \{i', j'\}| = 1$ . Notice that no vertex  $q_{i,j}$  of  $Q$  has a neighbor  $z$  not in  $C \cup X$ , otherwise  $\{q_{i,j}, v_i, v_j, z\}$  would induce a claw in  $G$ , a contradiction.

We will prove now that the non-empty  $Q_i$ 's belong to different connected components of  $G - (V(C) \cup Q)$ . By the way of contradiction, let  $P$  be a path in  $G - (V(C) \cup Q)$  of minimum length joining two vertices  $w_i \in Q_i$  and  $w_j \in Q_j$  with  $i \neq j$ . By construction,  $P$  has length at least two and has no internal vertices that belong to  $V(C) \cup X$ . On one hand, if  $|N_C(w_i) \cap N_C(w_j)| = 1$ , then  $G$  would contain a chordless cycle of length greater than  $n$ , a contradiction. On the other hand, if  $N_C(w_i) \cap N_C(w_j) = \emptyset$ , then  $G$  would contain an induced prism, also a contradiction.

So, indeed each of the non-empty  $Q_i$ 's belong to a different connected component  $R_i$  of  $G - (V(C) \cup Q)$ . Since  $G$  is prime, it follows that if  $Q_i$  were non-empty then  $|V(R_i)| = 1$ . Otherwise, let  $w_i \in Q_i$ . Then  $V(R_i) \cup \{v_i\}$  and  $(V(G) \setminus V(R_i)) \cup \{w_i\}$  would be a split decomposition of  $G$ , with  $v_i$  and  $w_i$  as marker vertices, respectively.

Consider now two nonadjacent 4-vertices  $v$  and  $w$ . Then, the edges of  $C$  with either both endpoints in  $N_C(v)$  (say  $v$ -edges) or both endpoints in  $N_C(w)$  (say  $w$ -edges) are exactly four. We will prove that traversing the edges of  $C$  in clockwise order,  $v$ -edges and  $w$ -edges do not alternate, other-

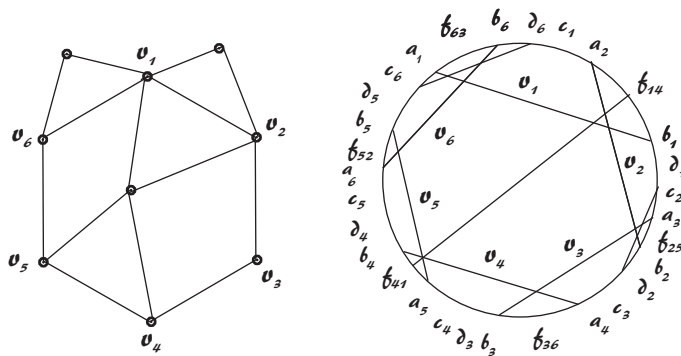

Figure 3.2: Prime graph and its circle model.

wise  $G$  would contain an induced prism. Suppose by the way of contradiction that the edges in clockwise order are  $e_1, e_2, e_3, e_4$  where  $e_1, e_3$  are  $v$ -edges and  $e_2, e_4$  are  $w$ -edges. Either  $e_1$  and  $e_2$ , or  $e_2$  and  $e_3$  are nonconsecutive in  $C$ , since  $e_1$  and  $e_3$  are at least two edges apart in  $C$ . Suppose without loss of generality that  $e_1$  and  $e_2$  are nonconsecutive in  $C$ . Let  $z_1^i$  and  $z_2^i$  be the endpoints of  $e_i$  in clockwise order. Then, by removing vertices  $z_2^3$  and  $z_1^4$  and the clockwise path in  $C$  linking them from  $G[V(C) \cup \{v, w\}]$ , a prism arises: the triangles are  $\{z_1^1, z_2^1, v\}$  and  $\{w, z_1^2, z_2^2\}$ ;  $w$  is linked with  $z_1^1$  via  $z_2^4$  and the path in  $C$  joining  $z_2^4$  and  $z_1^1$  (they might be the same vertex);  $z_1^1$  and  $z_2^1$  are different and linked by a path in  $C$ ;  $z_2^2$  and  $v$  are linked via  $z_1^3$  and the path in  $C$  joining  $z_2^2$  and  $z_1^3$  (they might be the same vertex).

Next, we will build a circle model for  $G$ . Draw a circle  $C$  and mark on  $C$ , in clockwise order, the following points:  $c_n, a_1, f_{n,3}, \dots, f_{n,n-3}, b_n, d_n, c_1, a_2, f_{1,4}, \dots, f_{1,n-2}, b_1, d_1, c_2, a_3, f_{2,5}, \dots, f_{2,n-1}, b_2, d_2, \dots, c_{n-1}, a_n, f_{n-1,2}, \dots, f_{n-1,n-4}, b_{n-1}, d_{n-1}$ . Finally, draw the chords  $a_i b_i$  for  $i = 1, \dots, n$ , the chord  $c_i d_i$  for each  $i$  in  $\{1, \dots, n\}$  such that  $Q_i$  is non-empty, and the chord  $f_{i,j} f_{j,i}$  for each  $i, j$  in  $\{1, \dots, n\}$  such that  $q_{i,j} \in Q$  (see Fig 3.2).  $\square$

**Remark 1.** A theta is a graph arising from  $K_{2,3}$  by edge subdivision. Chudnovsky and Kapadia [CK08] gave a polynomial-time algorithm that decides whether a graph contains a theta or a prism as induced subgraphs. Since linear domino graphs contain no induced theta, the characterization above and the existence of polynomial-time algorithms for recognizing circle graphs imply alternative polynomial-time algorithms to decide the existence of an induced theta or prism restricted to linear domino graphs. Interestingly enough, the problem of deciding whether a graph contains an induced prism is NP-complete in general [LLMT09].



### 3.3 Superclasses of cographs

In this section we characterize circle graph within two important superclasses of cographs:  $P_4$ -tidy graphs and tree-cographs. The reader interested in an overview of this classes is referred to Subsection 1.2.3.

Let  $G_1$  and  $G_2$  be two graphs and assume that  $V(G_1) \cap V(G_2) = \emptyset$ . The *disjoint union* of  $G_1$  and  $G_2$  is the graph  $G_1 \cup G_2$  such that  $V(G_1 \cup G_2) = V(G_1) \cup V(G_2)$  and  $E(G_1 \cup G_2) = E(G_1) \cup E(G_2)$ . We denote by  $G_1 + G_2$  the *join graph* of  $G_1$  and  $G_2$ , where  $V(G_1 + G_2) = V(G_1) \cup V(G_2)$  and  $E(G_1 + G_2) = E(G_1) \cup E(G_2) \cup \{uv : u \in V(G_1) \text{ and } v \in V(G_2)\}$ .

**Theorem 29.** [Gol04, p. 252]. *Permutation graphs are exactly those circle graphs that have a circle model admitting an equator, i.e. an additional chord meeting all the chords of the model.*

As an immediate consequence, we obtain the following corollary.

**Corollary 7.**  $G^+$  is a circle graph if and only if  $G$  is a permutation graph.

The following result is a consequence of the corollary above.

**Lemma 3.** *The join  $G = G_1 + G_2$  is a circle graph if and only if both  $G_1$  and  $G_2$  are permutation graphs.*

*Proof.* Straightforward. □

#### 3.3.1 $P_4$ -tidy graphs

The following lemma can be easily proved by means of elemental geometrical arguments.

**Lemma 4.** *Let  $G$  be a graph and let  $H$  be a graph obtained from  $G$  by adding either a pendant vertex, or a true or false twin of a vertex. Then,  $H$  is a circle graph if and only if  $G$  is a circle graph.*

**Theorem 30.** *Let  $G$  be a  $P_4$ -tidy graph. Then,  $G$  is a circle graph if and only if  $G$  contains no  $W_5$ ,  $net^+$ ,  $tent^+$ , or tent-with-center as induced subgraph.*

*Proof.* It is easy to see that  $net^+$ ,  $tent^+$ , and tent-with-center are not circle graphs. Since the class of circle graphs is hereditary, a circle graph contains no induced  $net^+$ ,  $tent^+$ , or tent-with-center.

Conversely, let  $G$  be a  $P_4$ -tidy graph that is not a circle graph. Then,  $G$  contains some induced graph  $H$  that is minimally not circle; i.e.,  $H$  is not a circle graph but all proper induced subgraphs of  $H$  are circle graphs.

Because of the minimality,  $H$  is connected. Suppose first that  $\overline{H}$  is disconnected; i.e.,  $H = H_1 + H_2$  for some graphs  $H_1$  and  $H_2$ . By Lemma 3, since  $H$  is not a circle graph,  $H_1$  or  $H_2$  is not a permutation graph. By Corollary 2,  $H_1$  or  $H_2$  contains an induced  $C_5$ , net, or tent. Thus,  $H = H_1 + H_2$  contains an induced  $W_5$ , net<sup>+</sup>, or tent<sup>+</sup>. By minimality,  $H = W_5$ , net<sup>+</sup>, or tent<sup>+</sup>. Suppose, on the contrary, that  $\overline{H}$  is connected. By Theorem 10, since  $H$  is a  $P_4$ -tidy graph, either  $H$  is  $C_5$ ,  $P_5$ ,  $\overline{P_5}$ , a spider, or a fat spider. Since  $H$  is not a circle graph,  $H$  is different from  $C_5$ ,  $P_5$ , and  $\overline{P_5}$ . Thus,  $H$  is a spider or a fat spider. By Lemma 4 and the minimality,  $H$  has no true or false twins, so  $H$  is not a fat spider. We conclude that  $H$  is a spider. Let  $(S, C, R)$  be the spider partition of  $H$ . By Lemma 4 and the minimality,  $H$  is necessarily a thick spider with  $|S| \geq 3$ . Since tent is a circle graph, either  $|S| \geq 4$  or  $R \neq \emptyset$ . In both cases,  $H$  contains an induced tent-with-center and, by minimality,  $H = \text{tent-with-center}$ .  $\square$

### 3.3.2 Tree cographs

**Theorem 31.** *Let  $G$  be a tree-cograph. Then,  $G$  is a circle graph if and only if  $G$  contains no induced (bipartite-claw)<sup>+</sup> and no induced co-(bipartite-claw).*

*Proof.* It is easy to see that bipartite-claw<sup>+</sup> and co-(bipartite-claw) are not circle graphs and thus a circle graph contains none of those graphs as induced subgraph. Conversely, let  $G$  be a tree-cograph that is not a circle graph. Therefore, there exists some connected component  $H$  of  $G$  that is not a circle graph. Notice that  $H$  cannot be a tree because trees are circle graphs. Since  $H$  is a tree-cograph and  $H$  is connected,  $\overline{H}$  is disconnected or  $\overline{H}$  is a tree. Suppose first that  $\overline{H}$  is disconnected. Then,  $H = H_1 + H_2$  for some graphs  $H_1$  and  $H_2$ . By Lemma 3, we can assume without loss of generality that  $H_1$  is not a permutation graph. Corollary 2 implies that  $H_1$  would contain an induced bipartite-claw, and so  $H = H_1 + H_2$  would contain an induced (bipartite-claw)<sup>+</sup>. Finally, consider the case when  $\overline{H}$  is a tree. Since  $H$  is not a circle graph, in particular it is not a permutation graph. By Corollary 2,  $H$  contains an induced co-(bipartite-claw).  $\square$

## 3.4 Unit Helly circle graphs

A graph  $G$  is a *unit circle* graph if it admits a circle model in which all the chords have the same length. This class coincides with the class of unit circular-arc graphs (i.e., the intersection graphs of a family of arcs on a circle, all of the same length) [Dur03]. Tucker gave a characterization by minimal forbidden induced subgraphs for this class [Tuc74]. Recently, linear and quadratic-time recognition algorithms for this class have been proposed [LS06b, DGM<sup>+</sup>06].

The concept of *Helly circle graph* is due to Durán [Dur03]. A graph belongs to this class if it has a circle model whose chords are pairwise different and satisfy the Helly property (i.e., every subset of pairwise intersecting chords has a common point). In [Dur03], it was conjectured that a circle graph is a Helly circle graph if and only if it is diamond-free. This conjecture was recently settled affirmatively in [DGR10], yielding a polynomial-time recognition algorithms for Helly circle graphs.

In the theorem below we completely characterize unit Helly circle graphs.

**Theorem 32.** *Let  $G$  be a graph. Then, the following assertions are equivalent:*

1.  $G$  is a unit Helly circle graph.
2.  $G$  contains no induced claw, paw, diamond, or  $C_n^*$  for any  $n \geq 3$ .
3.  $G$  is a chordless cycle, a complete graph, or a disjoint union of chordless paths.

*Proof.* Let us consider the case when  $G$  is triangle-free. Suppose first that 1 holds. Since  $G$  is a unit circle graph,  $G$  is a unit circular-arc graph. Thus,  $G$  contains no induced claw or  $C_n^*$  for any  $n \geq 4$  [Tuc74]. This proves  $1 \Rightarrow 2$  (in the case when  $G$  is triangle-free). Suppose now that 2 holds. If  $G$  has no cycles, then each connected component of  $G$  is a claw-free tree, i.e.,  $G$  is the disjoint union of chordless paths. So, assume that  $G$  has some cycle. Since  $G$  is triangle-free, the shortest cycle  $H$  of  $G$  is a chordless cycle of length at least 4. Since  $G$  contains no induced claw, triangle, or  $C_n^*$  for any  $n \geq 4$ ,  $G = H$ . We conclude that  $2 \Rightarrow 3$ . Finally, it is easy to build unit Helly circle models of chordless cycles and of disjoint unions of chordless paths. Consequently,  $3 \Rightarrow 1$  also holds.

Let us now consider the case when  $G$  is not triangle-free. Suppose that 1 holds and let  $\mathcal{L} = \{L_i\}_{i=1}^n$  be a unit Helly model of  $G$  on a circle  $\mathcal{C}$ , where  $n = |V(G)|$ . If two different chords  $L_1$  and  $L_2$  on  $\mathcal{C}$  have the same length, then  $L_1$  and  $L_2$  are diameters of  $\mathcal{C}$  or both of them are tangent to a circle  $\mathcal{C}'$  concentric with  $\mathcal{C}$ . Since  $G$  is not triangle-free, we can assume that  $L_1$ ,  $L_2$ , and  $L_3$  are three pairwise intersecting chords and, since  $\mathcal{L}$  has the Helly property, there is a point  $P \in L_1 \cap L_2 \cap L_3$ . We claim that  $L_1$ ,  $L_2$ , and  $L_3$  are diameters of  $\mathcal{C}$ . Otherwise,  $L_1$ ,  $L_2$ , and  $L_3$  would be three different tangents to a circle  $\mathcal{C}'$  through  $P$  and this would lead to a contradiction, because it is well-known that there are at most two different tangents to a circle passing through a given point. Since all chords of  $\mathcal{L}$  have all the same length, then  $\mathcal{L}$  is a family of diameters of  $\mathcal{C}$  and, therefore,  $G$  is a complete. We conclude that  $1 \Leftrightarrow 3$  because complete graphs are clearly unit Helly circle graphs. Finally, given that  $G$  contains a triangle, it is straightforward that  $G$  is complete if and only if  $G$  contains no induced

$C_3^*$ , paw, or diamond. (Notice that  $C_3^*$ , paw, and diamond are all the four-vertex graphs that contain the triangle as induced subgraph and that are not complete.) We conclude that  $2 \Leftrightarrow 3$  also holds.  $\square$

---

## Chapter 4

# Probe interval graphs

In 1994, Zhag et al. introduced probe interval graphs as a research tool in the frame of the genome project [ZSF<sup>+</sup>94]. In this chapter we investigate probe interval graphs and probe unit interval graphs from a combinatorial viewpoint. We particularly focus on forbidden induced subgraphs characterizations for probe interval graphs and probe unit interval graphs. Some antecedents on the subject can be found in [She99], [BLS09], [BL06], and [PC05]. During the last years, probe  $\mathcal{G}$  graphs have been studied for many hereditary classes of graphs  $\mathcal{G}$ , probe chordal graphs [GL04], probe permutation graphs [CCK<sup>+</sup>09] and probe split graphs [LdR07] among others. We characterize by a set of minimal forbidden induced subgraph probe interval graphs and probe unit interval graphs within tree-cographs,  $P_4$ -tidy graphs and co-bipartite graphs.

This chapter is organized as follows. In Section 2 we state the necessary results used throughout of this chapter. In Section 3, we characterize probe interval graphs within the class of co-bipartite graphs. In Section 4, we give the forbidden subgraphs characterizations of probe interval graphs among tree-cographs and  $P_4$ -tidy graphs. Even though these results can be proved using tools developed in the following section, we preferred to postpone their use for the convenience of the reader, presenting an alternative proof that implicitly uses these tools. Section 5 is devoted to introduce the concept of companion of a hereditary class of graphs. In Section 6 and Section 7, using the concept of companion introduced in Section 5, we characterize probe  $\{3K_1, C_4, C_5\}$ -free graphs and probe unit interval graphs, respectively. These results appear in [DGS].

### 4.1 Preliminaries

Let  $G = (V, E)$  be a graph. Denote by  $(N, P)$  a partition of  $V$  such that  $N$  is a stable set. Let  $F$  be a set of nonedges of  $G$  whose endpoints belong to  $N$ . A *completion* of  $G$  is a graph  $G^* = (V, E')$  whose edge set is  $E' = E \cup F$ .

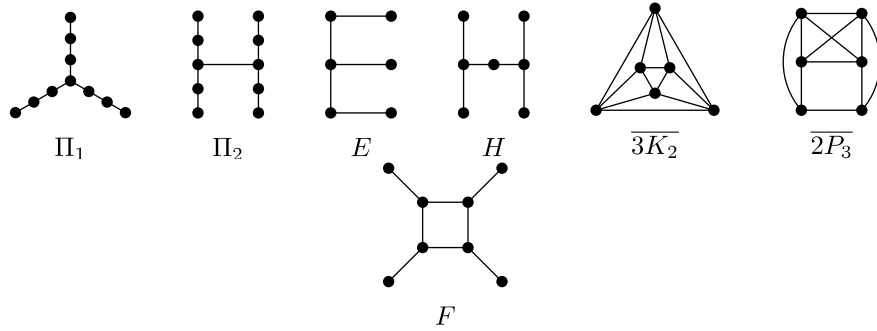

Figure 4.1: Some small graphs

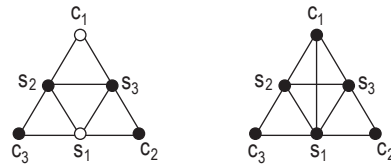

Figure 4.2: Example of a probe interval graph. The white vertices of the graph on the left represent the nonprobe vertices.

Let  $\mathcal{G}$  be a hereditary class of graphs. The graph  $G$  is defined to be *probe*  $\mathcal{G}$  if there exists a partition  $(N, P)$  of  $V$  and a set of nonedges  $F$  in  $G$  whose endpoints belong to  $N$  such that the completion  $G^* = (V, E \cup F)$  of  $G$  belongs to  $\mathcal{G}$ . Under such conditions,  $(N, P)$  is called a *probe  $\mathcal{G}$  partition* of  $G$ , the vertices in  $N$  and  $P$  are called *nonprobe vertices* and *probe vertices*, respectively.

Let us see an example of probe interval graph. Consider the graph  $H = (V, E)$  isomorphic to the tent whose vertices are labelled as in Figure 4.1 and let  $H^* = (N \cup P, E \cup F)$  be a probe interval completion of  $H$ . Notice that if  $(N, P)$  is a probe interval partition of  $H$ , then  $c_i \in N$  for some  $i = 1, 2, 3$ . Suppose, by way of contradiction, that  $c_i \in P$  for all  $i = 1, 2, 3$ . Therefore, since  $H$  is not interval, at least two vertices of the set  $\{s_1, s_2, s_3\}$  belong to  $N$  and at least a nonedge  $s_i s_j$  with  $i \neq j$  belongs to  $F$ . Consequently,  $\{s_i, s_j, c_i, c_j\}$  induces the graph  $C_4$  in  $H^*$ , this leads to a contradiction because  $H^*$  is an interval graph. Suppose, without loss of generality, that  $c_1 \in N$ . So,  $s_i, c_i \in P$  for  $i = 2, 3$  and thus  $s_1 \in N$  and  $F = \{c_1, s_1\}$  (see the graph on the left in Figure 4.1). It is easy to check that such a completion is an interval graph (see the graph on the right in Figure 4.1).

Those trees that are probe interval graphs or probe unit interval graphs have been characterized by means of forbidden induced subgraphs in [She99] and [BLS09], respectively.

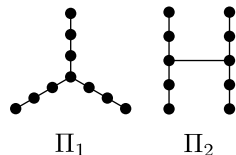

Figure 4.3: Minimally not probe interval trees.

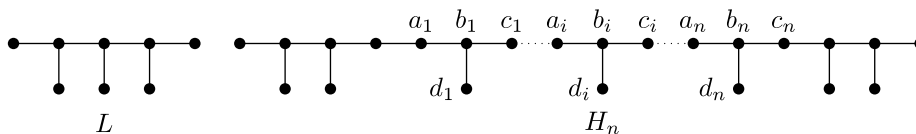

Figure 4.4: Minimally not probe unit interval trees.

**Theorem 33.** [She99] *Let  $G$  be a tree. Then,  $G$  is a probe interval graph if and only if  $G$  contains no induced  $\Pi_1$  or  $\Pi_2$  (see Fig. 4.3).*

**Theorem 34.** [BLS09] *Let  $G$  be a tree. Then,  $G$  is a probe unit interval graph if and only if  $G$  contains no induced bipartite claw,  $L_2$ , or  $H_n$  for any  $n \geq 0$  (see Fig 4.4).*

## 4.2 Co-bipartite graphs

In [BL06], is presented a characterization by means of forbidden induced subgraphs of those bipartite graphs that are probe interval. In addition, it is showed the relationship between probe interval graphs, bigraphs and the complements of circular-arc graphs within the class of bipartite graphs. In this section we present a forbidden induced subgraph characterization for probe interval graphs within the class of those graphs whose complement is bipartite. Furthermore, we show that, restricted to the class of co-bipartite graphs, probe interval graphs, probe  $\{3K_1, C_4, C_5\}$ -free graphs and probe unit interval graphs are the same classes.

Given a graph  $G$ ,  $D \subseteq V(G)$  is called a *dominating set* if every vertex  $v \in V(G)$  either belongs to  $D$  or is adjacent to a vertex in  $D$ .

**Lemma 5.** [LZ94] *Let  $G$  be a triangle free graph.  $G$  is  $\{P_6, C_6\}$ -free if and only if every induced connected subgraph of  $G$  has a dominating complete bipartite subgraph isomorphic to  $K_{n,m}$  with  $n, m \geq 1$ .*

The following lemma follows from Lemma 5.

**Lemma 6.** *Let  $G = (V, E)$  be a connected bipartite  $\{2P_3, 3K_2, P_6, C_6, F\}$ -free graph. Then, either  $G$  has diameter at most 3, or there exists a pendant vertex  $v \in V$  such that  $H = G[V - v]$  has diameter at most 3.*

*Proof.* Let  $G$  be a connected bipartite  $\{2P_3, 3K_2, P_6, C_6, F\}$ -free graph. By Lemma 5, since  $G$  is bipartite and  $\{P_6, C_6\}$ -free there exists a dominating complete bipartite graph  $H = (V', E')$  such that  $V'$  can be partitioned into two stable sets  $A$  and  $B$ . Since  $G$  is bipartite, either  $N_{V(H)}(v) \cap A = \emptyset$  or  $N_{V(H)}(v) \cap B = \emptyset$  for every vertex  $v \in V - (A \cup B)$ . We will call  $A'$  the set of vertices of  $V \setminus V'$  whose neighbors belong to  $A$  and  $B'$  the set of vertices of  $V \setminus V'$  whose neighbors belong to  $B$ . Assume that there exist two vertices  $u, v \in V$  such that  $d(u, v) = 4$ . Notice that either  $u, v \in A'$  or  $u, v \in B'$ . Suppose, without loss generality, that  $u, v \in A'$ , let  $u' \in A$  and  $v' \in A$  be a neighbor of  $u$  and  $v$ , respectively. On the one hand, since  $G$  is  $F$ -free,  $\bigcap_{b' \in B'} N(b') \neq \emptyset$ ; i.e., all vertices in  $B'$  have a common neighbor. Consequently, given a vertex  $b' \in B'$ ,  $d(b', z) \leq 3$  for all vertices  $z \in V$ . On the other hand, since  $G$  is  $3K_2$ -free, every vertex  $w \in A'$  is either adjacent to  $u'$  or adjacent to  $v'$ . Since  $G$  is  $2P_3$ -free, either  $u$  or  $v$  is a pendant vertex. If  $A' = \{u, v\}$ ,  $u$  or  $v$  would satisfy the condition of the lemma. So, we can assume that  $A' \setminus \{u, v\} \neq \emptyset$ . Suppose, without loss of generality that  $u$  is the pendant vertex. Since  $G$  is  $2P_3$ -free, if  $u_1 \in A' \setminus \{u\}$  is adjacent to  $u'$  and  $v_1 \in A' \setminus \{v\}$  is adjacent to  $v'$ , then  $u_1$  is adjacent to  $v'$  or  $v_1$  is adjacent to  $u'$ . Consequently,  $u$  is a pendant vertex satisfying the conditions of the lemma.  $\square$

Lemma 6 implies the following characterization.

**Theorem 35.** *Let  $G$  be a co-bipartite graph. Then, the following statements are equivalent:*

1.  $G$  is a probe interval graph;
2.  $G$  is a probe unit interval graph;
3.  $G$  is probe  $\{3K_1, C_4, C_5\}$ -free;
4.  $G$  is  $\{\overline{2P_3}, \overline{3K_2}, \overline{P_6}, \overline{C_6}, \overline{F}\}$ -free.

*Proof.* It is easy to see that  $\overline{2P_3}, \overline{3K_2}, \overline{P_6}, \overline{C_6}$  and  $\overline{F}$  are neither probe interval, nor probe unit interval, nor probe  $\{3K_1, C_4, C_5\}$ -free.

Conversely, let  $G = (V, E)$  be a  $\{\overline{2P_3}, \overline{3K_2}, \overline{P_6}, \overline{C_6}, \overline{F}\}$ -free co-bipartite graph. Consider the complement graph of  $G$ ,  $\overline{G}$ . By Theorem 2, if  $\overline{G}$  had diameter at most 3; i.e.,  $\overline{G}$  were  $2K_2$ -free, then  $G$  would be an interval graph. Therefore, we can assume that  $\overline{G}$  has diameter 4. By Lemma 6, there exists a pendant vertex  $v \in V$ , whose neighbor we will call  $v'$ , such that  $H = \overline{G}[V - v]$  has diameter at most 3. Consequently, the completion



$G^*(N \cup P, E \cup F)$ , where  $N = \{v, v'\}$ ,  $P = V \setminus N$  and  $F = \{vv'\}$ , is an interval graph. Finally, since  $G^*$  is also co-bipartite and interval,  $G$  is  $\{C_4, C_5\}$ -free,  $3K_1$ -free (consequently, claw-free) and thus  $\{3K_1, C_4, C_5\}$ -free and unit interval. Therefore,  $G$  is probe  $\{3K_1, C_4, C_5\}$ -free and probe unit interval.  $\square$

As a consequence of Lemma 6, we obtain the following corollary.

**Corollary 8.** *Let  $G$  be the complement of a tree. Then, the following assertions are equivalent:*

1.  $G$  is a probe  $\{3K_1, C_4, C_5\}$ -free graph.
2.  $G$  is a probe unit interval graph.
3.  $G$  is a probe interval graph.
4.  $G$  is  $\{\overline{3K_2}, \overline{2P_3}, \overline{P_6}\}$ -free.
5.  $G$  is  $\{\text{co-bipartite-claw}, \overline{H}, \overline{P_6}\}$ -free.

(Here, 4. is a minimal forbidden induced subgraph characterization, while 5. is a minimal forbidden connected induced subgraph characterization.)

*Proof.* The equivalence between the first four statements follows from Theorem 35.

Let us see the equivalence between 4. and 5.. Since  $\overline{G}$  is  $\{3K_2, 2P_3, P_6\}$ -free, then  $\overline{G}$  is  $\{\text{bipartite-claw}, H, P_6\}$ -free. Conversely, let  $\overline{G}$  be a  $P_6$ -free tree. If  $\overline{G}$  contains either an induced  $2P_3$  or an induced  $3K_2$ , then  $\overline{G}$  contains either an induced  $H$  or an induced bipartite-claw, respectively.  $\square$

The following theorem gives a forbidden induced subgraph characterization of probe  $\{3K_1, C_4, C_5\}$ -free graphs among trees. The class of the probe  $\{3K_1, C_4, C_5\}$ -free graphs will be useful in the following sections when dealing with the class of probe unit interval graphs.

**Theorem 36.** *Let  $G$  be a tree. Then, the following assertions are equivalent:*

1.  $G$  is a probe  $\{3K_1, C_4, C_5\}$ -free graph.
2.  $G$  contains no induced  $2K_2 \cup K_1$  or  $P_4 \cup K_1$ .
3.  $G$  contains no induced  $E$  or  $P_6$ .

(Here, 2. is a minimal forbidden induced subgraph characterization, while 3. is a minimal forbidden connected induced subgraph characterization.)

*Proof.* First, we will prove the equivalence between 1. and 3.. It is straightforward to verify that  $E$  and  $P_6$  are not probe  $\{3K_1, C_4, C_5\}$ -free graphs. Conversely, suppose that  $G$  is  $\{E, P_6\}$ -free. Let  $P = v_1v_2v_3 \cdots v_n$  be a path of maximum length of  $G$ . Since  $G$  is a tree and  $P$  is of maximum length,  $v_1$  and  $v_n$  are pendant vertices of  $G$ . Since  $G$  contains no induced  $P_6$ ,  $n \leq 5$ . Since  $G$  is an  $E$ -free tree and  $P$  is of maximum length, for each  $i \in \{2, \dots, n-1\}$ , the neighbors of  $v_i$  in  $G$  different from  $v_{i-1}$  and  $v_{i+1}$  are pendant vertices of  $G$ . If  $n \leq 3$ ,  $G$  is probe complete and, in particular, it is a probe  $\{3K_1, C_4, C_5\}$ -free graph. So, assume that  $4 \leq n \leq 5$ . If  $n = 5$ ,  $d_G(v_3) = 2$  because  $G$  contains no induced  $E$ . Let  $N_1 = N_G(v_2) \setminus \{v_3\}$  and let  $N_2 = N_G(v_{n-1}) \setminus \{v_2\}$  (so, if  $n = 5$ ,  $N_2 = N_G(v_{n-1})$ ). Hence, we split  $V(G)$  into  $N = N_1 \cup N_2$  which is clearly an independent set of  $G$  and  $P = V(G) - N$ . The graph  $G^*$  that arises from  $G$  by adding all the edges joining two vertices of  $N_1$  and all the edges joining two vertices of  $N_2$  is  $3K_1$ -free and chordal. Thus,  $G^*$  is a  $\{3K_1, C_4, C_5\}$ -free completion of  $G$ .

It can be easily seen that if  $G$  is  $\{2K_2 \cup K_1, P_4 \cup K_1\}$ -free, then  $G$  does not contain any induced  $E$  and  $P_6$ . Conversely, if  $G$  is  $P_6$ -free and  $G$  contains either an induced  $2K_2 \cup K_1$  or an induced  $P_4 \cup K_1$  and  $G$  is a tree, then  $G$  contains an induced  $E$ . Consequently, if  $G$  is a  $\{E, P_6\}$ -free tree, then  $G$  contains no induced  $2K_2 \cup K_1$  or  $P_4 \cup K_1$ . □

### 4.3 Probe interval graphs

**Lemma 7.** *Let  $G_1$  and  $G_2$  be two graphs. Then,  $G_1 + G_2$  is an interval graph if and only if one of  $G_1$  and  $G_2$  is interval and the other one is complete.*

*Proof.* Since interval graphs are a hereditary class, if  $G_1 + G_2$  is an interval graph then  $G_1$  and  $G_2$  are interval graphs. Suppose that none of  $G_1$  and  $G_2$  is complete. Then, there exist two nonadjacent vertices  $v_1^i, v_2^i \in V(G_i)$  for  $i = 1, 2$ . Consequently,  $\{v_1^1, v_2^1, v_1^2, v_2^2\}$  induces  $C_4$  in  $G_1 + G_2$  and thus  $G_1 + G_2$  is not interval. Conversely, suppose that  $G_1$  or  $G_2$  is interval and the other one a complete, say  $G_1$  is interval and  $G_2$  is a complete. So, we can construct an interval model for  $G_1 + G_2$  from the interval model  $\mathcal{I}$  of  $G_1$  by adding as many intervals as the number of vertices of  $G_2$ , covering the whole interval model  $\mathcal{I}$ . □

**Lemma 8.** *Let  $G_1$  and  $G_2$  be two graphs. Then,  $G_1 + G_2$  is a probe interval graph if and only if only if one of the following assertions holds:*

1. *One of  $G_1$  and  $G_2$  is complete and the other one is probe interval.*
-

2. One of  $G_1$  and  $G_2$  is probe complete and the other one is interval.

*Proof.* Let  $G_1$  and  $G_2$  be two graphs and let  $H = G_1 + G_2$  be probe interval. Therefore, there exists a probe interval completion  $H^* = (N \cup P, E \cup F)$  of  $H$  such that  $H^*$  is an interval graph. Since  $H = G_1 + G_2$ , either  $N \subseteq V(G_1)$  or  $N \subseteq V(G_2)$ . Assume, without loss of generality, that  $N \subseteq V(G_1)$ ; i.e.,  $H^* = G_1^* + G_2$  with  $G_1^* = (V(G_1), E(G_1) \cup F)$ . By Lemma 7, since  $H^*$  is an interval graph, one of  $G_1^*$  and  $G_2$  is a complete and the other one is interval. So, either  $G_1$  is probe complete and  $G_2$  is an interval graph or  $G_1$  is a probe interval and  $G_2$  is a complete.  $\square$

Notice the following immediate class inclusion:

$$\text{complete} \subseteq \text{probe complete} \subseteq \text{interval} \subseteq \text{probe interval}.$$

The following Theorem characterizes all minimal not probe interval graphs whose complement is disconnected.

**Theorem 37.** *The minimally not probe interval graphs whose complement is disconnected are bipartite-claw +  $2K_1$ , umbrella +  $2K_1$ ,  $n$ -net +  $2K_1$  for any  $n \geq 2$ ,  $n$ -tent +  $2K_1$  for any  $n \geq 3$ ,  $\overline{3K_2}$ , or  $\overline{2P_3}$ .*

*Proof.* Let  $G$  be a minimally not probe interval graph whose complement is disconnected. Therefore, there exist two graphs  $G_1$  and  $G_2$  such that  $G$  is the join between them; i.e.,  $G = G_1 + G_2$ . By minimality,  $G_1$  and  $G_2$  are probe interval. Since  $G = G_1 + G_2$  is not probe interval, by Lemma 7, none of  $G_1$  and  $G_2$  is complete.

Suppose that one of  $G_1$  and  $G_2$  is probe complete, say  $G_2$ . Then,  $G_1$  is not interval because otherwise  $G_1 + G_2$  would be probe interval. Since, for each  $v_1 \in V(G_1)$ ,  $(G_1 - v_1) + G_2$  is probe interval and  $G_2$  is not complete,  $G_1 - v_1$  is an interval graph. Thus,  $G_1$  is a minimally not interval graph. Since, for each  $v_2 \in V(G_2)$ ,  $G_1 + (G_2 - v_2)$  is probe interval and  $G_1$  is not interval,  $G_2 - v_2$  is complete. Since  $G_2$  is not complete,  $G_2 = 2K_1$ . Since  $G_1$  is probe interval,  $G_1$  is not a cycle of length at least 5 (see Lemma ??). We conclude that  $G$  equals bipartite-claw +  $2K_1$ , umbrella +  $2K_1$ ,  $n$ -net +  $2K_1$  for some  $n \geq 2$ ,  $n$ -tent +  $2K_1$  for some  $n \geq 3$ , or  $C_4 + 2K_1 = \overline{3K_2}$ .

We can now assume that  $G_1$  and  $G_2$  are not probe complete. Therefore, since  $(G_1 - v_1) + G_2$  is probe interval,  $G_1 - v_1$  is probe complete, for each  $v_1 \in V(G_1)$ . So  $G_1$  is a minimally not probe complete, i.e.,  $\overline{P_3}$  or  $C_4$  (see Lemma 1). Symmetrically,  $G_2$  is  $\overline{P_3}$  or  $C_4$ . If  $G_1 = C_4$  or  $G_2 = C_4$ , then  $G$  contains a proper induced  $C_4 + 2K_1$ , a contradiction. So,  $G = \overline{2P_3}$ .  $\square$

The following theorem characterizes those probe interval graphs among tree-cographs.

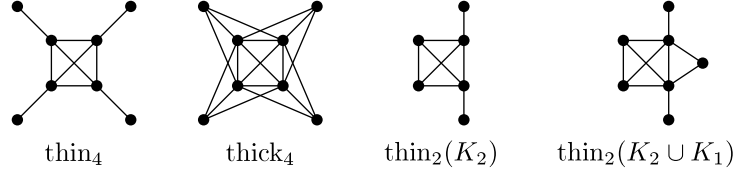

Figure 4.5: Some spiders.

**Theorem 38.** *Let  $G$  be a tree-cograph. Then,  $G$  is a probe interval graph if and only if  $G$  contains no induced  $\Pi_1$ ,  $\Pi_2$ , bipartite-claw +  $2K_1$ ,  $\overline{3K_2}$ ,  $\overline{2P_3}$ , or  $\overline{P_6}$ .*

*Proof.* It suffices to prove that if  $G$  is a tree-cograph not probe interval graph, then  $G$  contains an induced  $\Pi_1$ ,  $\Pi_2$ , bipartite-claw +  $2K_1$ ,  $\overline{3K_2}$ ,  $\overline{2P_3}$ , or  $\overline{P_6}$ .

So, assume that  $G$  is not a probe interval tree-cograph. Therefore,  $G$  contains an induced subgraph  $H$  that is a minimally not probe interval graph. Since  $G$  is a tree-cograph,  $H$  is also a tree-cograph. Consequently,  $H$  is disconnected, or the complement of  $H$  is disconnected, or  $H$  is a tree, or  $H$  is the complement of a tree. By minimality of  $H$ ,  $H$  is not disconnected because the disjoint union of probe interval graphs is also a probe interval graph. If the complement of  $H$  is disconnected, then (by Theorem 37)  $H$  equals bipartite-claw +  $2K_1$ ,  $\overline{3K_2}$  or  $\overline{2P_3}$  (notice that umbrella +  $2K_1$ ,  $n$ -net +  $2K_1$  for any  $n \geq 2$ , and  $n$ -tent +  $2K_1$  for any  $n \geq 3$  are not tree-cographs). If  $H$  is a tree, Theorem 33 implies that  $H$  equals  $\Pi_1$  or  $\Pi_2$ . Finally, consider the case when  $H$  is the complement of a tree. By Theorem 8,  $H$  equals  $\overline{3K_2}$ ,  $\overline{2P_3}$ , or  $\overline{P_6}$ .  $\square$

In order to characterize those probe interval graphs among  $P_4$ -tidy graphs, we need the following lemma that characterizes those spiders that are probe interval.

**Lemma 9.** *Let  $H$  be a spider with spider partition  $(C, S, R)$ . Then,  $H$  is probe interval if and only if one of the following conditions holds:*

1.  $|C| = 3$  and  $H[R]$  is interval.
2.  $|C| = 2$  and  $H[R]$  is probe interval.

*Moreover, if  $H$  is probe interval, then a fat spider  $H'$  that arises from  $H$  is also probe interval except when  $|C| = 2$ ,  $H'$  arises by making a false twin of a vertex of  $C$ , and  $H[R]$  is not interval.*

*Proof.* Let  $H = (V, E)$  be a thick (thin) spider with partition  $(C, S, R)$  that is probe interval with a completion  $H^* = (V, E \cup F)$  and probe interval partition  $(N, P)$ . Suppose that  $|C| \geq 4$  and let  $c_1, c_2, c_3, c_4$  be different

vertices in  $C$ . Notice that if a tent (net) is an induced subgraph of  $H$ , then exactly a vertex of degree four (three) belongs to  $N$ . Let  $s_1, s_2, s_3, s_4$  be different vertices of  $S$  such that  $s_i$  adjacent to any vertex in  $C$  but  $c_i$  ( $s_i$  is only adjacent to  $c_i$ ) for all  $1 \leq i \leq |C|$ . So,  $\{c_1, c_2, c_3, s_1, s_2, s_3\}$  induces a tent (net) and thus one of  $c_1, c_2, c_3$  belongs to  $N$ , say  $c_1$ . Analogously,  $\{c_2, c_3, c_4, s_2, s_3, s_4\}$  also induces a tent (net) and one of  $c_2, c_3, c_4$  belongs to  $N$ , but all of them are adjacent to  $c_1$ , a contradiction. Consequently,  $2 \leq |C| \leq 3$ . Assume that  $|C| = 3$ . Since  $H$  is probe interval,  $H[C \cup R] = H[C] + H[R]$  is also probe interval. On the one hand, since  $H[C]$  is a complete, by Lemma 8,  $H[R]$  is probe interval. On the other hand, since  $\{s_1, s_2, s_3, c_1, c_2, c_3\}$  induces a tent (net), one of the vertices in  $C$  is nonprobe and thus any vertex in  $R$  is probe. So,  $H[R]$  is interval. Now, assume that  $|C| = 2$ . Since  $C$  is a complete and  $H$  is probe interval,  $H[C] + H[R]$  is probe interval. Thus, by Lemma 8,  $H[R]$  is probe interval. Conversely, it is straightforward to construct a probe interval model of a thick (thin) spider that satisfies condition 1. or 2..

Let  $H'$  be a fat spider that arises from  $H$ . If  $H'$  arises by making a twin of a vertex  $s \in S$ , then  $H'$  is also probe interval. Indeed, if  $H^* = (V(H), E(H) \cup F)$  is a probe interval completion of  $H$  with a probe interval partition  $(N, P)$  chosen (by symmetry) in such a way that  $s \in N$  if  $s'$  is a false twin and  $sinP$  if  $s'$  is a true twin, then  $(N, P)$  can be extended to a probe interval partition  $(N'P')$  of  $H'$  by taking also the twin  $s'$  of  $s$  as a nonprobe vertex ( $N' = N \cup \{s\}$ ) if it is a false twin and as a probe vertex ( $P' = P \cup \{s\}$ ) if it is a true twin. Therefore,  $H'^* = (N' \cup P, E(H') \cup F')$ , with  $F' = F \cup \{ss'\} \cup \{vs' : vs \in F\}$  if  $s'$  is a false twin and  $F' = F$  if  $s'$  is a true twin, is interval because the graph obtained by adding true twins to an interval graph is also interval. Suppose now that  $H'$  arises from a vertex  $c \in C$  by making a true twin. Then  $H'$  is probe interval. In fact, any partition  $(N, P)$  of  $H$  where  $c \in P$  can be extended to a partition of  $H'$  where the new vertex is also a probe vertex. Finally, consider the case where  $H$  arises by making a false twin of a vertex  $c \in C$ . If  $H[R]$  were not interval and thus  $|C| = 2$ , then  $H$  would contain  $H[R] + 2K_1$ , where  $H[R]$  is a forbidden induced subgraph for the class of interval graphs. Therefore,  $H'$  would not be probe interval. Notice that if  $H[R]$  is interval, then clearly  $H'$  is an interval, simply look for a partition where  $c$  and the false twin of it are both nonprobe, and the vertices of  $R$  are all probe.  $\square$

Let  $\mathcal{H}$  be the set formed by all the minimally not interval graphs but the induced cycles with at least five vertices.

The graphs belonging to  $\mathcal{H}$  are probe interval. In addition, it can be proved that every probe interval partition of a graph belonging to  $\mathcal{H}$  contains at least two nonadjacent probe interval vertices. Therefore, the graph that arises from a graph belonging to  $\mathcal{H}$  by adding two nonadjacent universal

vertices is a minimally not probe interval.

**Corollary 9.** *The minimally not probe interval graphs that are spiders or fat spiders are the graphs:  $thick_3(H)$ ,  $thin_3(H)$ , for  $H \in \mathcal{H}$ ,  $thin_4$  and  $thick_4$ .*

*Proof.* It is straightforward to check that all the graphs of the corollary are minimally not probe interval. Let  $G$  be a thick (thin) spider with partition  $(C, S, R)$  that is minimally not probe interval. If  $|C|$  were of size at least 4, then  $G$  would contain  $thick_4$  ( $thin_4$ ) as induced subgraph and by minimality  $G = thick_4$  ( $G = thin_4$ ). Now, we may assume that  $|C| \leq 3$ . Indeed, by Lemma 9, since  $G$  is not probe interval, it suffices to consider  $|C| = 3$ . By minimality,  $G[R]$  is probe interval and by Lemma 9 it cannot be an interval graph. By Theorem 2, the only minimal not interval graphs that are probe interval are those graphs belonging to  $\mathcal{H}$ . Therefore,  $G$  contains  $thick_3(H)$  ( $thin_3(H)$ ) for some  $H \in \mathcal{H}$  as induced subgraph. Furthermore, by minimality,  $G$  is exactly that graph.

Let  $G$  be a fat spider that is a minimally not probe interval. By Corollary 9,  $G$  arises from a spider with  $|C| = 2$  and  $H[R]$  is not an interval graph by making a false twin of a vertex in  $C$ . Assume that  $C = \{c_1, c_2\}$ ,  $S = \{s_1, s_2\}$  and  $v$  is a false twin of  $c_1$ . By minimality  $G - v$  is probe interval. By Lemma 9 and minimality,  $H[R]$  is probe interval but it is not an interval graph. Consequently,  $H[R]$  contains an induced minimally not interval graph  $W$ . By minimality,  $W \in \mathcal{H}$ . Since  $v$  is not adjacent to  $c_1$  and they are complete to  $W$ ,  $G$  contains an induced  $U = W + 2K_2$  with  $W \in \mathcal{H}$ . By Lemma 8 it follows that  $U$  is minimally not probe interval. By minimality,  $G = U$ , this leads to a contradiction because  $U$  is not a spider.  $\square$

**Theorem 39.** *Let  $G$  be a  $P_4$ -tidy graph. Then,  $G$  is a probe interval graph if and only if  $G$  contains no induced  $net + 2K_1$ ,  $tent + 2K_1$ ,  $\overline{3K_2}$ ,  $\overline{2P_3}$ ,  $C_5$ ,  $thin_3(net)$ ,  $thick_3(net)$ ,  $thin_3(tent)$ ,  $thick_3(tent)$ ,  $thin_4$ , or  $thick_4$ .*

*Proof.* Let  $G$  be a minimally not probe interval graph that is a  $P_4$ -tidy graph. By minimality,  $G$  is connected. If  $\overline{G}$  were disconnected then, by Theorem 37,  $G$  would be isomorphic to either  $net + 2K_1$ , or  $tent + 2K_1$ , or  $\overline{3K_2}$ , or  $\overline{2P_3}$ . So, we may assume that  $\overline{G}$  is connected. By Theorem 10,  $G$  is  $C_5$ ,  $P_5$ ,  $\overline{P_5}$ , a spider or a fat spider. Notice that  $P_5$  and  $\overline{P_5}$  are probe interval graphs. So,  $G$  is isomorphic to  $C_5$  or, by Corollary 9,  $G$  is isomorphic to either  $thin_3(H)$ , or  $thick_3(H)$ , for  $H \in \{net, tent\}$ , or  $thin_4$ , or  $thick_4$ .  $\square$

## 4.4 Graphs classes with a companion

Let  $\mathcal{G}$  be a hereditary class.  $\mathcal{P}(\mathcal{G})$  denotes the class of probe  $\mathcal{G}$  graphs. We say that a class  $\mathcal{H}$  is the *companion* of  $\mathcal{G}$  if and only if, given any two graphs

$G_1$  and  $G_2$ , the following holds:  $G_1 + G_2 \in \mathcal{G}$  if and only if one of  $G_1$  and  $G_2$  is complete and the other one belongs to  $\mathcal{H}$ .

For example, by Lemma 7, the class of interval graphs is its own companion and the companion of the class of unit interval graphs is the class of  $\{3K_1, C_4, C_5\}$ -free graphs. Notice that the companion of the class  $\{3K_1, C_4, C_5\}$ -free is itself.

In what follows, we denote by  $\mathcal{K}$  the class of nonempty complete graphs.

**Lemma 10.** *Let  $\mathcal{G}$  be a hereditary graph class and  $\mathcal{H}$  be its companion. Then, the following assertions hold:*

1.  $\mathcal{K} \subseteq \mathcal{H} \subseteq \mathcal{G}$ .
2.  $\mathcal{H}$  is a hereditary class.
3.  $\mathcal{H}$  is its own companion.
4.  $C_4 \notin \mathcal{G}$ .
5. If  $\mathcal{H} \neq \mathcal{K}$ , then  $C_4$  is a minimally not  $\mathcal{G}$  graph and a probe  $\mathcal{H}$  graph.

*Proof.* Let  $H \in \mathcal{H}$ . Since  $\mathcal{H}$  is the companion of  $\mathcal{G}$ ,  $K_n + H \in \mathcal{G}$  for every positive integer  $n$ . Since  $\mathcal{G}$  is hereditary,  $\mathcal{K} \subseteq \mathcal{G}$  and  $\mathcal{H} \subseteq \mathcal{G}$ . Since  $\mathcal{K} \subseteq \mathcal{G}$ ,  $K_n + K_n \in \mathcal{G}$  for every positive integer  $n$ , and therefore  $\mathcal{K} \subseteq \mathcal{H}$ . We conclude that  $\mathcal{K} \subseteq \mathcal{H} \subseteq \mathcal{G}$ . On the other hand, since  $\mathcal{G}$  is an hereditary class  $H' + K_1 \in \mathcal{G}$  for any  $H'$  subgraph of  $H$ . Therefore,  $H' \in \mathcal{K} \subseteq \mathcal{H}$  or  $H' \in \mathcal{H}$ . Consequently,  $\mathcal{H}$  is a hereditary class. 3. is immediate from 1. and the definition of hereditary class with a companion.  $C_4$  does not belong to  $\mathcal{G}$  because  $C_4 = 2K_1 + 2K_1$  and  $2K_1 \notin \mathcal{K}$ .

Assume now that  $\mathcal{H} \neq \mathcal{K}$ . Since  $\mathcal{H}$  is hereditary,  $2K_1 \in \mathcal{H}$  and consequently  $P_3 = K_1 + 2K_1 \in \mathcal{G}$ . Moreover, since  $2K_1 \in \mathcal{H}$ ,  $K_1 + \text{diamond} = K_3 + 2K_1 \in \mathcal{G}$ , which implies that  $\text{diamond} \in \mathcal{H}$ . Therefore,  $C_4$  is minimally not a  $\mathcal{G}$  graph but it is a probe  $\mathcal{H}$  graph.  $\square$

The following lemma shows the behavior of the join operator respect to a hereditary class with a companion.

In what follows, a graph  $G$  is said to be a  $\mathcal{G}$ -graph for a class  $\mathcal{G}$  if  $G$  belongs to the class  $\mathcal{G}$ .

**Lemma 11.** *Let  $\mathcal{G}$  be a hereditary graph class with companion  $\mathcal{H}$  and let  $G_1$  and  $G_2$  be two nonempty graphs. Then,  $G_1 + G_2$  is a probe  $\mathcal{G}$  graph if and only if at least one of the following conditions holds:*

1. One of  $G_1$  and  $G_2$  is complete and the other one is a probe  $\mathcal{H}$ -graph.

2. One of  $G_1$  and  $G_2$  is probe complete and the other one is an  $\mathcal{H}$ -graph.

*Proof.* The “if” part is straightforward. So, we are going to prove the “only if” part. Let  $G = G_1 + G_2$  be a probe  $\mathcal{G}$  graph, with  $\mathcal{G}$  a hereditary class with a companion  $\mathcal{H}$ . Therefore, there exists a completion  $G^* = (V(G), E(G) \cup F)$  with a probe interval partition  $(N, P)$  such that  $G^* \in \mathcal{G}$ . Since  $N$  is an independent set,  $N \subseteq V(G_1)$  or  $N \subseteq V(G_2)$ . Assume, without loss of generality, that  $N \subseteq V(G_1)$  and we call  $G_1^*$  to the graph whose vertex set is  $V(G_1)$  and whose edge set is  $E(G_1) \cup F$ . Consequently, since  $\mathcal{H}$  is the companion of  $\mathcal{G}$ , either  $G_1^*$  is complete ( $G_1$  is probe complete) or  $G_1^* \in \mathcal{H}$  ( $G_1$  is probe  $\mathcal{H}$ ) and  $G_2 \in \mathcal{H}$  or  $G_2$  is complete, respectively.  $\square$

The following theorem gives a tool to calculate the minimally not probe  $\mathcal{G}$  graphs for a hereditary class  $\mathcal{G}$  with a companion  $\mathcal{H} \neq \mathcal{K}$ .

**Theorem 40.** *Let  $\mathcal{G}$  be a hereditary graph class and  $\mathcal{H}$  be its companion. If  $\mathcal{H} \neq \mathcal{K}$ , then the only minimally not probe  $\mathcal{G}$  graphs with disconnected complements are:*

1. the graphs  $F + K_1$  for each  $F \in \mathcal{P}(G)$  that is minimally not probe  $\mathcal{H}$ ;
2. the graphs  $F + 2K_1$  for each  $F \in \mathcal{P}(G)$  that is minimally not  $\mathcal{X}$ , where  $\mathcal{X} = \mathcal{P}(\mathcal{K}) \cup \mathcal{H}$ ;
3. the graphs  $F_1 + F_2$  for each  $F_1, F_2 \in \mathcal{P}(K)$  that are minimally not  $\mathcal{H}$ ;
4. the graph  $\overline{2P_3}$ .

*Proof.* Let  $G$  be a minimally not probe  $\mathcal{G}$  graph with disconnected complement. Then,  $G = G_1 + G_2$  where  $G_1$  and  $G_2$  are nonempty graphs.

Suppose that  $G_2$  is a complete. Since  $G_1 + G_2$  is not a probe  $\mathcal{G}$  graph,  $G_1$  is not a probe  $\mathcal{H}$  graph, see Lemma 11. By minimality and Lemma 11,  $G_2$  is isomorphic to  $K_1$  and thus  $G_1 + K_1$  is not probe  $\mathcal{G}$ . Since  $G_1$  is not a probe  $\mathcal{H}$  graph, in particular,  $G_1$  is not complete. Since  $(G_1 - v_1) + K_1$  is probe  $\mathcal{G}$ ,  $G_1 - v_1$  is a probe  $\mathcal{H}$  graph for each  $v_1 \in V(G_1)$ . So,  $G$  is isomorphic to  $F + K_1$  where  $F$  is minimally not probe  $\mathcal{H}$  and a probe  $\mathcal{G}$  graph. In what follows, we can assume that  $G_1$  and  $G_2$  are not complete.

Suppose that  $G_2$  contains an induced  $C_4$ . Since  $(G_1 - v_1) + C_4$  is probe  $\mathcal{G}$  and  $C_4$  is neither an  $\mathcal{H}$  graph nor probe complete, then  $G_1 - v_1$  is complete for each  $v_1 \in V(G_1)$ . So, by Lemma 11, since  $G_1$  is not complete,  $G_1$  is isomorphic to  $2K_1$ . Since  $C_4 + 2K_1$  is not a probe  $\mathcal{G}$  graph, by minimality  $G = C_4 + 2K_1$ . Notice that  $C_4$  is minimally not  $\mathcal{X}$  and probe  $\mathcal{G}$ . In what follows, we can assume that  $G_1$  and  $G_2$  contain no induced  $C_4$ .

---



Suppose that  $G_2$  is probe complete and an  $\mathcal{H}$  graph. Since  $G_1 + G_2$  is not a probe  $\mathcal{G}$  graph,  $G_1$  is not a  $\mathcal{X}$  graph. Since  $(G_1 - v_1) + G_2$  is probe a  $\mathcal{G}$  graph,  $G_1 - v_1$  is a  $\mathcal{X}$  graph. So,  $G_1$  is minimally not  $\mathcal{X}$  graph. Since  $G_1 + (G_2 - v_2)$  is a probe  $\mathcal{G}$  graph,  $G_2 - v_2$  is complete for each  $v_2 \in V(G_2)$ . Since  $G_2$  is not complete,  $G_2 = 2K_1$ . So,  $G = F + 2K_1$  where  $F$  is a minimally not  $\mathcal{X}$  graph that is probe  $\mathcal{G}$ .

Suppose that  $G_2$  is probe complete but it is not an  $\mathcal{H}$  graph. Since  $G_1 + G_2$  is not a probe  $\mathcal{G}$  graph,  $G_1$  is not an  $\mathcal{H}$  graph. Since  $(G_1 - v_1) + G_2$  is a probe  $\mathcal{G}$  graph,  $G_1 - v_1$  is an  $\mathcal{H}$  graph. So,  $G_1$  is minimally not  $\mathcal{H}$ . Suppose, by way of contradiction, that  $G_1$  is not probe complete. Since  $G_1 + (G_2 - v_2)$  is a probe  $\mathcal{G}$  graph,  $G_2 - v_2$  is complete for each  $v_2 \in V(G_2)$ . Since  $G_2$  is not complete,  $G_2$  is isomorphic to  $2K_1$ . Since  $G_2$  is not an  $\mathcal{H}$  graph, then  $\mathcal{H} \subseteq \mathcal{K}$ , a contradiction. The contradiction arose by assuming that  $G_1$  is not probe complete. Therefore,  $G_1$  is probe complete. Since  $G_1$  is not an  $\mathcal{H}$  graph, by symmetry,  $G_2$  is a minimally not  $\mathcal{H}$  graph. We conclude that  $G = F_1 + F_2$  where  $F_1$  and  $F_2$  are minimally not  $\mathcal{H}$  graphs and probe complete.

Finally, we can assume that  $G_1$  and  $G_2$  are not probe complete. Since  $G_1$  and  $G_2$  contain no induced  $C_4$ , by Lemma 1,  $G_1$  and  $G_2$  contain an induced  $\overline{P_3}$  each. By minimality,  $G$  is isomorphic to  $\overline{2P_3}$ .  $\square$

Notice that Theorem 37 follows easily from the above theorem. Indeed, by Lemma 7, the class  $\mathcal{I}$  of interval graphs is the companion of itself. Since  $\mathcal{P}(\mathcal{K}) \subseteq \mathcal{I}$ ,  $\mathcal{P}(\mathcal{K}) \cup \mathcal{I} = \mathcal{I}$  and none of the minimally not  $\mathcal{I}$  graphs is probe complete, the only minimally not  $\mathcal{I}$  graphs that are not probe  $\mathcal{I}$  graphs are the cycles  $C_n$  for each  $n \geq 5$ .

**Remark 2.** *If  $\mathcal{H} = \mathcal{K}$ , the graphs belonging to  $\mathcal{G}$  are  $P_3$ -free (i.e., are disjoint unions of completes) and the minimally not probe  $\mathcal{G}$  graphs with disconnected complement are  $C_4$  and  $\overline{2P_3}$ , if  $\overline{2P_3} \notin \mathcal{G}$ ; or  $C_4$  and paw, otherwise.*

## 4.5 Partial characterization of probe $\{3K_1, C_4, C_5\}$ -free graphs

Threshold graphs, introduced by Chvátal and Hammer in 1975 [CH75], can be defined as  $\{2K_2, P_4, C_4\}$ -free graphs. Threshold graphs are a subclass of split graphs. For more details of this class of graphs see [Gol04] or Section 1.2.

**Lemma 12.** *The minimally not probe  $\{3K_1, C_4, C_5\}$ -free graphs that are disconnected are  $2K_2 \cup K_1$ ,  $P_4 \cup K_1$ , and  $C_4 \cup K_1$ .*

*Proof.* It is straightforward to check that  $2K_2 \cup K_1$ ,  $P_4 \cup K_1$ , and  $C_4 \cup K_1$  are minimally not probe  $\{3K_1, C_4, C_5\}$ -free graphs.

Conversely, let  $H$  be a disconnected minimally not probe  $\{3K_1, C_4, C_5\}$ -free graph. Suppose, by the way of contradiction, that  $H$  does not contain  $2K_2 \cup K_1$ ,  $P_4 \cup K_1$ , and  $C_4 \cup K_1$  as induced subgraph. Consequently,  $H$  is either a threshold graph or the union of two threshold graphs  $H_1, H_2$  with no induced  $K_2 \cup K_1$  (i.e., split complete graphs).

In the first case, let  $N$  be the stable set in the split partition of  $H$ . The graph  $H^*$  that arises from  $H$  by adding all the edges  $uv$  with  $u, v \in N$  is co-bipartite. So,  $H^*$  is a completion of  $H$  with partition  $(N, P)$  ( $P = V(H) - N$ ) that is  $\{3K_1, C_5\}$ -free. Next, we will prove that  $H^*$  is also  $C_4$ -free. Let  $A = \{u, v, x, y\}$  be a set of vertices of  $H^*$  such that  $H^*[A]$  is isomorphic to  $C_4$ . Notice that, by construction, we can assume that  $u, v \in N$ ,  $x, y \in P$ ,  $u$  is adjacent to  $x$  and  $v$  is adjacent to  $y$ . But then  $A$  induces a  $P_4$  in  $H$ , a contradiction.

In the second case, let  $N$  be the union of the stable sets in the split partitions of  $H_1$  and  $H_2$ . Let  $H^*$  be the graph that arises from  $H$  by adding all the edges  $uv$  with  $u, v \in N$ . Then  $H^*$  can be obtained from  $P_4$  by adding true twin vertices. It is easy to see then that it is  $\{3K_1, C_4, C_5\}$ -free.  $\square$

As a consequence of Theorem 40 we can calculate all minimally not probe  $\{3K_1, C_4, C_5\}$ -free graphs whose complement are disconnected.

In what follows,  $\mathcal{T}$  and  $\mathcal{L}$  denote the class of  $\{3K_1, C_4, C_5\}$ -free graphs and  $\mathcal{P}(\mathcal{K}) \cup \mathcal{T}$  respectively.

**Lemma 13.** *The minimally not probe  $\{3K_1, C_4, C_5\}$ -free graphs with disconnected complement are  $(K_2 \cup 2K_1) + 2K_1$ ,  $(P_3 \cup K_1) + 2K_1$ ,  $\overline{3K_2}$ ,  $K_{3,3}$ , and  $\overline{2P_3}$ .*

*Proof.* Recall that the class  $\mathcal{T}$  is its own companion. Let  $F$  be a minimally not  $\mathcal{L}$  graph. We claim that  $F$  isomorphic to either  $K_2 \cup 2K_1$ , or  $P_3 \cup K_1$ , or  $C_4$ , or  $C_5$ . Indeed, since  $F$  is not a  $\mathcal{T}$  graph,  $F$  contains an induced  $3K_1$ ,  $C_4$ , or  $C_5$ . If  $F$  contained an induced  $C_4$  or  $C_5$ , then, by minimality,  $F$  would be either isomorphic to  $C_4$ , or isomorphic to  $C_5$ . So, we may assume that  $F$  contains an induced  $3K_1$  and no induced  $C_4$  or  $C_5$ . Let  $S$  be a set that induces a  $3K_1$  in  $F$ . Since  $F$  is not probe complete and  $F$  contains no induced  $C_4$ ,  $F$  contains an induced  $\overline{P_3}$  (see Lemma 1). Let  $W$  be a set that induces a  $\overline{P_3}$  in  $F$  and  $e = uv$  be the only edge joining two vertices of  $W$  in  $F$ . If  $e$  has one endpoint either in  $S$  or adjacent to a vertex in  $S$  (say  $u$ ), then  $F$  contains an induced  $K_2 \cup 2K_1$  or  $P_3 \cup K_1$ , or  $S \cup \{v\}$  induces a claw. If  $F$  contains an induced  $K_2 \cup 2K_1$  or  $P_3 \cup K_1$ , then, by minimality,  $F$  is either isomorphic to  $K_2 \cup 2K_1$  or isomorphic to  $P_3 \cup K_1$ . Suppose, by way of contradiction, that  $F$  contains neither an induced  $K_2 \cup 2K_1$  nor an induced  $P_3 \cup K_1$ . Then,  $S \cup \{v\}$  induces a claw. Let  $w$  be such that

$W = \{u, v, w\}$ . Since  $F$  contains no induced  $P_3 \cup K_1$ ,  $w$  is adjacent to both vertices of  $S - \{u\}$  and consequently  $F$  contains an induced  $C_4$ , a contradiction. Notice that  $K_2 \cup 2K_1$ ,  $P_3 \cup K_1$ ,  $C_4$  are probe  $\{3K_1, C_4, C_5\}$ -free graphs, but  $C_5$  is not a probe  $\{3K_1, C_4, C_5\}$ -free graphs. Finally, the only minimally not  $\mathcal{T}$  graph that is probe complete is  $3K_1$ . The results follows now from Theorem 40.  $\square$

**Theorem 41.** *Let  $G$  be a tree-cograph. Then,  $G$  is a probe  $\{3K_1, C_4, C_5\}$ -free graph if and only if  $G$  contains no induced  $2K_2 \cup K_1$ ,  $P_4 \cup K_1$ ,  $C_4 \cup K_1$ ,  $(K_2 \cup 2K_1) + 2K_1$ ,  $(P_3 \cup K_1) + 2K_1$ ,  $\overline{3K_2}$ ,  $K_{3,3}$ ,  $\overline{2P_3}$ , or  $\overline{P_6}$ .*

*Proof.* Let  $H$  be a minimally not probe  $\{3K_1, C_4, C_5\}$ -free graph that is a tree-cograph. If  $H$  is disconnected,  $H$  is  $2K_2 \cup K_1$ ,  $P_4 \cup K_1$ , or  $C_4 \cup K_1$ . If  $\overline{H}$  is disconnected,  $H$  is  $(K_2 \cup 2K_1) + 2K_1$ ,  $(P_3 \cup K_1) + 2K_1$ ,  $\overline{3K_2}$ ,  $K_{3,3}$ , or  $\overline{2P_3}$ . By Theorem 36, there are no minimal probe  $\{3K_1, C_4, C_5\}$ -free graphs that are trees. If  $\overline{H}$  is the complement of a tree, by Theorem 8,  $H$  is  $\overline{P_6}$ , or  $\overline{2P_3}$ , or  $\overline{3K_2}$ .  $\square$

**Lemma 14.** *Let  $H$  be a spider with spider partition  $(S, C, R)$ . Then,  $H$  is probe  $\{3K_1, C_4, C_5\}$ -free graph if and only if  $H = \text{thin}_2(tK_1)$  for some  $t \geq 0$ . Moreover, if  $H$  is a probe  $\{3K_1, C_4, C_5\}$ -free graph and  $H'$  is a fat spider that arises from  $H$ , then  $H'$  is also a probe  $\{3K_1, C_4, C_5\}$ -free graph except when  $t \geq 1$  and  $H'$  arises from  $H$  by making a false twin of a vertex of  $C$ .*

*Proof.* Let  $H$  be a spider with partition  $(S, C, R)$ . Since  $H$  is  $P_4 \cup K_1$ -free and tent-free,  $|C| = 2$ . Notice that  $R$  is an independent set because  $\text{thin}_2(K_2)$  is not probe  $\{3K_1, C_4, C_5\}$ -free graph. We conclude that  $H = \text{thin}_2(tK_1)$  for some  $t \geq 0$ . Clearly,  $\text{thin}_2(tK_1)$  is a probe  $\{3K_1, C_4, C_5\}$ -free graph. By setting all vertices of  $S \cup C$  as probe vertices ( $P$ ) and the vertices of  $R$  as nonprobe vertices ( $N$ ) and adding all the edges whose endpoints belong to  $N$  ( $F$ ), we obtain the completion  $H^* = (N \cup P, E(H) \cup F)$  of  $H$  that is  $\{3K_1, C_4, C_5\}$ -free. Therefore,  $H$  is probe  $\{3K_1, C_4, C_5\}$ -free.

Suppose that  $H$  is a probe  $\{3K_1, C_4, C_5\}$ -free graph and let  $H'$  be a fat spider arising from  $H$ . Let  $v$  a false twin of a vertex  $s \in S$ . Consider the following probe partition  $(N, P)$ :  $N = R \cup \{v, s\}$  and  $P = V(H) - N$  and denote by  $F$  the edges whose endpoints belong to  $N$ . Consequently, the completion  $H^* = (N \cup P, E(H) \cup F)$  is  $\{3K_1, C_4, C_5\}$ -free. Now, let  $v$  be a true twin of a vertex  $s \in S$ . Consider the following  $(N, P)$  probe partition:  $N = R \cup (S \setminus \{s, v\})$  and  $P = V(H) - N$ . So, the completion  $H^* = (V(H), E(H) \cup F)$  with probe partition  $(N, P)$ , where  $F$  are the edges whose endpoints belong to  $N$ , is  $\{3K_1, C_4, C_5\}$ -free. Therefore, if  $H'$  arises by making a twin of a vertex  $s \in S$ , then  $H'$  is a probe  $\{3K_1, C_4, C_5\}$ -free graph. We have already seen a probe interval partition of  $H$  where each  $c \in C$  is a probe vertex having a  $\{3K_1, C_4, C_5\}$ -free completion. Therefore,

if  $H'$  arises by making a true twin of a vertex of  $C$ ,  $H'$  is also a probe  $\{3K_1, C_4, C_5\}$ -free graph. Finally, assume that  $H'$  arises by making a false twin of a vertex  $c \in C$ . If  $t = 0$ , then  $H'$  is clearly a probe  $\{3K_1, C_4, C_5\}$ -free graph. If  $t \geq 1$ , then  $H'$  is not a probe  $\{3K_1, C_4, C_5\}$ -free graph because it contains an induced  $C_4 \cup K_1$ .  $\square$

**Lemma 15.** *The minimally not probe  $\{3K_1, C_4, C_5\}$ -free graphs that are spiders or fat spiders are tent and  $\text{thin}_2(K_2)$ .*

*Proof.* By minimality  $|C| \leq 3$  (otherwise contains  $P_4 \cup K_1$  or tent as proper induced subgraphs). If  $|C| = 3$ , then  $H$  is a thick spider (otherwise it contains  $P_4 \cup K_1$  as proper induced subgraph). If  $|C| = 3$  and  $H$  is thick, then  $H$  contains an induced tent and, by minimality,  $H = \text{tent}$ . Therefore, we can assume that  $|C| = 2$ . If  $H[R]$  were a stable set, then, by the above lemma,  $H$  is a spider, a contradiction. Therefore,  $R$  is not a stable set. So,  $H$  contains an induced  $\text{thin}_2(K_2)$  and, by minimality,  $H = \text{thin}_2(K_2)$ .

Suppose, by way of contradiction, that there is a fat spider  $H'$  that is minimally not probe  $\{3K_1, C_4, C_5\}$ -free graph. By minimality,  $H'$  arises from a spider  $H$  that is a probe  $\{3K_1, C_4, C_5\}$ -free graph. So, by the above lemma,  $H = \text{thin}_2(tK_1)$  for some  $t \geq 1$  and  $H$  arises by making a false twin of a vertex of  $C$ . Then,  $H'$  contains an induced  $C_4 \cup K_1$ . By minimality,  $H' = C_4 \cup K_1$ , this leads to a contradiction because  $H'$  is a fat spider. This contradiction proves that there are no minimally not  $\{3K_1, C_4, C_5\}$ -free graph that are fat spiders.  $\square$

By combining Lemmas 12, 13 and 15 it is obtained the following characterization.

**Theorem 42.** *Let  $G$  be a  $P_4$ -tidy graph. Then,  $G$  is a probe  $\{3K_1, C_4, C_5\}$ -free graph if and only if  $G$  contains no induced  $2K_2 \cup K_1$ ,  $P_4 \cup K_1$ ,  $C_4 \cup K_1$ ,  $(K_2 \cup 2K_1) + 2K_1$ ,  $(P_3 \cup K_1) + 2K_1$ ,  $\overline{3K_2}$ ,  $K_{3,3}$ ,  $\overline{2P_3}$ ,  $C_5$ , tent, or  $\text{thin}_2(K_2)$ .*

*Proof.* Let  $H$  be a minimally not  $\{3K_1, C_4, C_5\}$ -free graph that is a  $P_4$ -tidy graph. If  $H$  is disconnected, then  $H$  is isomorphic to either  $2K_2 \cup K_1$ , or  $P_4 \cup K_1$ , or  $C_4 \cup K_1$ . If  $\overline{H}$  is disconnected, then  $H$  is isomorphic to either  $(K_2 \cup 2K_1) + 2K_1$ , or  $(P_3 \cup K_1) + 2K_1$ , or  $\overline{3K_2}$ , or  $K_{3,3}$ , or  $\overline{2P_3}$ . If  $H$  were  $C_5$ ,  $P_5$ , or  $\overline{P_5}$ , then  $H$  would be necessarily isomorphic to  $C_5$ . Finally, if  $H$  is a spider or a fat spider, then  $H$  is tent or  $\text{thin}_2(K_2)$ .  $\square$

## 4.6 Partial characterizations of probe unit interval graphs

To the best of our knowledge, the problem of finding all minimally not probe unit interval graphs whose complement is disconnected remains open.

---

Nevertheless, we solve this problem for the classes of tree-cographs and  $P_4$ -tidy graphs.

**Lemma 16.** *The minimally not probe unit interval graphs that are tree-cographs or  $P_4$ -tidy and whose complement is disconnected are  $(2K_2 \cup K_1) + K_1$ ,  $(P_4 \cup K_1) + K_1$ ,  $(C_4 \cup K_1) + K_1$ ,  $\text{thin}_2(K_2) + K_1$ ,  $(K_2 \cup 2K_1) + 2K_1$ ,  $(P_3 \cup K_1) + 2K_1$ ,  $\overline{3K_2}$ ,  $K_{3,3}$ , and  $\overline{2P_3}$ .*

*Proof.* The result follows from Theorem 40. Indeed, the companion of the class of unit interval graphs is the class  $\mathcal{T}$ , and: (i) the minimally not probe  $\mathcal{T}$  graphs that are tree-cographs or  $P_4$ -tidy and are probe unit interval graphs are  $2K_2 \cup K_1$ ,  $P_4 \cup K_1$ ,  $C_4 \cup K_1$ , and  $\text{thin}_2(K_2)$ ; (ii) by the proof of Lemma 13, the minimal forbidden subgraphs of  $\mathcal{P}(\mathcal{K}) \cup \mathcal{T}$  are  $K_2 \cup 2K_1$ ,  $P_3 \cup K_1$ ,  $C_4$ , and  $C_5$  (all of which are probe unit interval except for  $C_5$ ); and (iii) the only minimally not  $\mathcal{T}$  graph that is probe complete graph is  $3K_1$ .  $\square$

**Theorem 43.** *Let  $G$  be a tree-cograph. Then,  $G$  is a probe unit interval graph if and only if  $G$  contains no induced  $L_1$ ,  $L_2$ ,  $H_n$  for any  $n \geq 1$ ,  $\overline{P_6}$ ,  $(2K_2 \cup K_1) + K_1$ ,  $(P_4 \cup K_1) + K_1$ ,  $(C_4 \cup K_1) + K_1$ ,  $(K_2 \cup 2K_1) + 2K_1$ ,  $(P_3 \cup K_1) + 2K_1$ ,  $\overline{3K_2}$ ,  $K_{3,3}$ , or  $\overline{2P_3}$ .*

*Proof.* Let  $H$  be a minimally not probe unit interval graph that is a tree-cograph. By minimality,  $H$  is connected. If  $H$  is a tree, then, by Theorem 34,  $H$  is bipartite claw,  $L_2$ , or  $H_n$  for some  $n \geq 1$ . If  $H$  is the complement of a tree, then, by Theorem 8,  $H$  is  $\overline{P_6}$ . If  $\overline{H}$  is disconnected, by Lemma 16,  $H$  is  $(2K_2 \cup K_1) + K_1$ ,  $(P_4 \cup K_1) + K_1$ ,  $(C_4 \cup K_1) + K_1$ ,  $(K_2 \cup 2K_1) + 2K_1$ ,  $(P_3 \cup K_1) + 2K_1$ ,  $\overline{3K_2}$ ,  $K_{3,3}$ ,  $\overline{2P_3}$  (because  $\text{thin}_2(K_2) + K_1$  is not a tree-cograph).  $\square$

**Lemma 17.** *Let  $H$  be a spider with spider partition  $(S, C, R)$ . Then,  $H$  is a probe unit interval if and only if  $|C| = 2$  and  $H[R]$  is probe complete. Moreover, if  $H$  is probe unit interval and  $H'$  is a fat spider that arises from  $H$ , then  $H'$  is also probe unit interval except when  $H[R]$  is not complete and  $H'$  arises by making a false twin of a vertex of  $C$ .*

*Proof.* Let  $H$  be a probe unit interval spider with spider partition  $(S, C, R)$ . Notice that  $|C| = 2$  because otherwise  $H$  would contain either an induced net or an induced tent. In addition,  $H[R]$  is  $\{\overline{P_3}, C_4\}$ -free (otherwise,  $H$  contains an induced  $\text{thin}_2(\overline{P_3})$  which is not a probe unit interval graph or  $(C_4 \cup K_1) + K_1$ ). So,  $H[R]$  is probe complete. Conversely, if  $H[R]$  is probe complete and  $|C| = 2$ , clearly  $H$  is a probe unit interval.

Suppose now that  $H$  is probe unit interval. The vertices of  $S$  in any probe interval partition of  $H$  can be probe or nonprobe, so if  $H'$  arises by making a twin of a vertex of  $S$ , then  $H'$  is also a probe unit interval. The vertices of  $C$  in any probe interval partition of  $H$  can be set as probe,

---

so if  $H'$  arises by making a true twin of  $C$ ,  $H'$  is also probe unit interval. Finally, suppose that  $H'$  arise from  $H$  by making a false twin of  $C$ . If  $H[R]$  is complete, then  $H'$  is clearly probe interval, but if  $H[R]$  is not complete,  $H'$  contains an induced  $(P_3 \cup K_1) + 2K_1$ .  $\square$

**Lemma 18.** *The minimally not probe unit interval graphs that are spiders or fat spiders are net, tent, and  $\text{thin}_2(\overline{P_3})$ .*

*Proof.* Let  $H$  be a spider with spider partition  $(S, C, R)$  that is a minimally not probe unit interval graph. If  $|C| \geq 3$ , by minimality  $H$  is net or tent. So we may assume that  $|C| = 2$ . Since  $H$  is not a probe unit interval graph,  $H[R]$  is not probe complete. So,  $H[R]$  contains an induced  $\overline{P_3}$  or  $C_4$ . If  $H[R]$  contained an induced  $C_4$ ,  $H$  would contain an induced  $(C_4 \cup K_1) + K_1$  and, by minimality,  $H = (C_4 \cup K_1) + 2K_1$ , contradicting the fact that  $H$  is a spider. So, necessarily  $H[R]$  contains an induced  $\overline{P_3}$ . Therefore,  $H$  contains an induced  $\text{thin}_2(\overline{P_3})$  and, by minimality,  $H = \text{thin}_2(\overline{P_3})$ .

Suppose by way of contradiction that there is a fat spider  $H'$  that is a minimally not unit interval graph. By the minimality and the above lemma,  $H'$  arises from a spider  $H$  with  $|C| = 2$  and  $H[R]$  probe complete by making a false twin of a vertex of  $C$ . But then,  $H'$  contains an induced  $(C_4 \cup K_1) + K_1$  and, by minimality,  $H = (C_4 \cup K_1) + 2K_1$ , contradicting again the fact that  $H$  is a fat spider.  $\square$

**Theorem 44.** *Let  $G$  be a  $P_4$ -tidy graph. Then,  $G$  is a probe unit interval graph if and only if  $G$  contains no induced  $(2K_2 \cup K_1) + K_1$ ,  $(P_4 \cup K_1) + K_1$ ,  $(C_4 \cup K_1) + K_1$ ,  $\text{thin}_2(K_2) + K_1$ ,  $(K_2 \cup 2K_1) + 2K_1$ ,  $(P_3 \cup K_1) + 2K_1$ ,  $\overline{3K_2}$ ,  $K_{3,3}$ ,  $\overline{2P_3}$ ,  $C_5$ , net, tent, or  $\text{thin}_2(\overline{P_3})$ .*

*Proof.* Let  $H$  be a minimally not unit interval graph that is  $P_4$ -tidy. By minimality,  $H$  is connected. If  $\overline{H}$  is disconnected, by Lemma 16,  $H$  is  $(2K_2 \cup K_1) + K_1$ ,  $(P_4 \cup K_1) + K_1$ ,  $(C_4 \cup K_1) + K_1$ ,  $\text{thin}_2(K_2) + K_1$ ,  $(K_2 \cup 2K_1) + 2K_1$ ,  $(P_3 \cup K_1) + 2K_1$ ,  $\overline{3K_2}$ ,  $K_{3,3}$ , or  $\overline{2P_3}$ . If  $H$  were  $C_5$ ,  $P_5$ , or  $\overline{P_5}$ , necessarily  $H = C_5$ . If  $H$  is a spider or a fat spider,  $H$  is net, tent, or  $\text{thin}_2(\overline{P_3})$ .  $\square$

## Chapter 5

# Probe co-bipartite and probe block graphs

In this chapter we present a structural characterization for *probe co-bipartite* graphs that leads to a polynomial-time recognition algorithm for this class. We also give a forbidden induced subgraph characterization for probe diamond-free graphs that implies a forbidden induced subgraph characterization for probe block graphs. Notice that block graphs are a subclass of chordal graphs. Probe chordal graphs have been studied in [GL04, CGLS10]. Two important subclasses of probe chordal graphs, probe split graphs and probe Ptolemaic graphs, have been studied in [LdR07] and [CCK<sup>+</sup>08], respectively. In [SHKP09], a linear-time recognition algorithm for probe block graphs is presented. Part of the results presented in this chapter were obtained during a visit to Universidade Federal do Rio de Janeiro [BDd<sup>+</sup>].

This chapter is organized as follows. Section 5.1 is devoted to probe co-bipartite graphs. In Section 5.2 is given a characterization of probe diamond-free graphs that implies a characterization for probe block graphs presented in the same section.

### 5.1 Probe co-bipartite graphs

Denote by  $T(G)$  the spanning subgraph of  $G$  formed by the edges contained in a triangle of  $G$ .

Before presenting the characterization of probe co-bipartite graphs, we would like to remark that if  $G$  is probe co-bipartite, then there exists a complete set  $C'$  in  $\overline{G}$  containing a set of edges  $E'$  such that  $\overline{G} - E'$  is bipartite. Consequently,  $G - E(C')$  is also bipartite. Moreover, for any clique  $C$  containing  $C'$ ,  $G - E(C)$  is bipartite.

Consequently, we have the following results.

**Lemma 19.** *Let  $G$  be a triangle-free graph. Then,  $G$  is probe co-bipartite if and only if  $\overline{G}$  contains an edge  $e$  such that  $\overline{G} - e$  is bipartite.*

**Lemma 20.** *Let  $G$  be a graph containing triangles. Then,  $G$  is probe co-bipartite if and only if  $T(\overline{G})$  has a clique  $C$  such that  $\overline{G} - E(C)$  is bipartite.*

*Proof.* Suppose that  $G$  is probe co-bipartite. Then,  $\overline{G}$  has a clique such that  $G - E(C)$  is bipartite. However, each edge of  $C$  is contained in a triangle. Therefore,  $C$  is a subgraph of  $T(\overline{G})$ , meaning that is a clique of  $T(\overline{G})$ . Conversely, suppose  $T(\overline{G})$  has a clique  $C$ , where  $G - E(C)$  is bipartite. Clearly any clique of  $T(\overline{G})$  is also a clique of  $\overline{G}$ . Consequently,  $\overline{G}$  has a clique  $C$ , such that  $G - E(C)$  is bipartite meaning that  $G$  is probe co-bipartite.  $\square$

**Theorem 45.** *Let  $G$  be a probe co-bipartite graph containing triangles. Then,  $T(\overline{G})$  is a split graph.*

*Proof.* By Lemmas 19 and 20,  $T(\overline{G})$  has a clique  $C$  such that  $\overline{G} - E(C)$  is bipartite. Let  $S$  be the subset of vertices of  $T(\overline{G})$  not contained in  $C$ . Suppose  $T(\overline{G})$  has an edge  $e$  linking two vertices of  $S$ . Then  $e$  forms a triangle with some vertex  $v$ . However, such a triangle has none of its edges in  $C$  and thus  $\overline{G} - E(C)$  cannot be bipartite, a contradiction. Therefore,  $T(\overline{G})$  is a split graph.  $\square$

**Algorithmic aspects:** If  $G$  is triangle-free, then check if for some edge  $e$ ,  $\overline{G} - e$  is bipartite. Otherwise, find all the triangles of  $\overline{G}$  and construct  $T(\overline{G})$ . Find each clique  $C$  of  $T(\overline{G})$  and verify for any  $C$  if  $\overline{G} - E(C)$  is bipartite. All these steps can be performed in polynomial time.

## 5.2 Probe block graphs

### 5.2.1 Probe diamond-free graphs

#### Partitioned probe diamond-free graphs

In what follows, we say that a graph  $G = (P \cup N, E)$  is a *partitioned graph* if its vertex set is partitioned into two sets: a set  $P$  of probe vertices and a stable set  $N$  of nonprobe vertices. Let  $\mathcal{G}$  be a hereditary class of graphs, we say that  $G$  is a *partitioned probe  $\mathcal{G}$  graph* if there exists a completion  $G^* = (P \cup N, E \cup F)$  of  $G$  belonging to  $\mathcal{G}$ , remember that all the edges belonging to  $F$  have both endpoints in  $N$ .

Let  $G = (P \cup N, E)$  and  $H = (P' \cup N', E')$  two partitioned graphs with  $N$  and  $N'$  stable sets.  $H$  is defined to be a *partitioned subgraph* (an *induced partitioned subgraph*) of  $G$ , if  $H$  is a subgraph (an induced subgraph) of  $G$ ,  $N' \subseteq N$  and  $P' \subseteq P$ . When the context is clear, we just say that  $H$  is



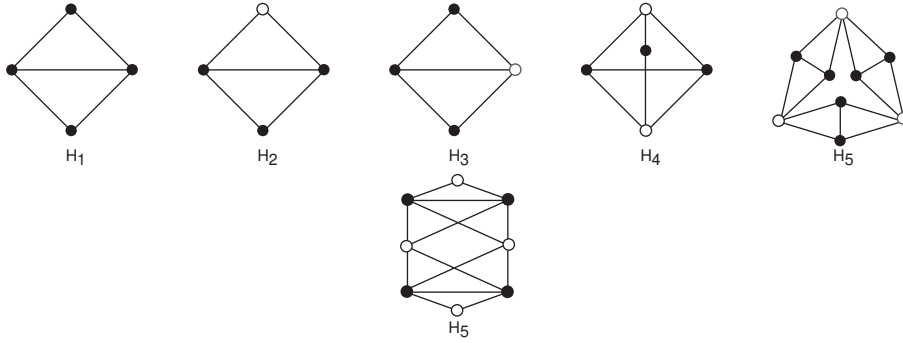

Figure 5.1: Partitioned forbidden subgraph for probe diamond-free graphs. Black vertices and white vertices represent probe vertices and nonprobe vertices, respectively.

(an induced) a subgraph of  $G$ . We say that  $G$  is isomorphic to  $H$  if and only if there exists a one-to-one function  $f : P \cup N \rightarrow P' \cup N'$  preserving adjacency and  $f(v) \in N'$  for all  $v \in N$ , and  $f(v) \in P'$  for all  $v \in P$ . We say that the partitioned graph  $G$  does not contain  $H$  as induced subgraph or does not contain an induced  $H$  if no induced partitioned subgraph of  $G$  is isomorphic to  $H$ . Given a set of partitioned graphs  $\mathcal{H}$ ,  $G$  is defined to be  $\mathcal{H}$ -free if  $G$  does not contain an induced  $H$  belonging to  $\mathcal{H}$ . If  $\mathcal{H}$  is a set with a single element  $H$ , we use  $H$ -free for short. We call *tips* to the vertices of degree two of the diamond.

In order to characterize probe block graphs, in this section we study the structure of probe diamond-free graphs. Giving the first step in characterizing probe block graphs, partitioned probe diamond-free graphs are characterized by forbidden partitioned subgraphs, by means of the following theorem.

**Theorem 46.** *Let  $G = (P \cup N, E)$  be a partitioned graph. Then,  $G$  is a partitioned probe diamond-free graph if and only if  $G$  does not contain any partitioned graph depicted in Figure 5.1.*

*Proof.* Let  $G$  be a partitioned graph not containing any induced partitioned graph depicted in Fig. 5.1. Let  $F$  be the set of non edges of  $G$  whose endpoints belong to  $N$  and are the tip of an induced diamond of  $G$ . It suffices to prove that the completion  $G^* = (N \cup P, E \cup F)$  of  $G$  is diamond-free. The proof follows by contradiction and is split into three cases. Suppose by the way contradiction that  $G^*$  is not diamond-free. Notice that it does not containing  $H_1$ ,  $H_2$  and  $H_3$  as induced subgraph,  $G^*$  does not contain any induced diamond with at most a nonprobe vertex and thus  $F$  is well-defined. In what follows, for any vertex  $v$ ,  $d(v)$  and  $d^*(G)$  denote  $d_G(v)$  and  $d_{G^*}(v)$ , respectively.

*Case 1:  $G^*$  contains a diamond with exactly two non probe vertices.* Assuming that  $u, v \in N$ ,  $uv \in F$  and  $x, y \in P$ , and suppose that  $H = G^*[\{u, v, x, y\}]$  is an induced diamond of  $G^*$ . First, suppose, without loss of generality, that  $d_H^*(u) = d_H^*(x) = 2$  and  $d_H^*(v) = d_H^*(y) = 3$ . Since,  $uv \in F$ , there exists a vertex  $w_1 \in P$  such that  $u, v$  and  $w_1$  belong to an induced diamond  $D$  in  $G$  and thus  $w_1$  is adjacent to  $u$  and  $v$ . Since  $G$  is  $\{H_2, H_3\}$ -free,  $w_1$  is not adjacent to  $x$  and  $y$ . Consequently, there exists a vertex  $w_2 \in D - H$  such that  $G[\{w_1, w_2, u, v\}] = D$  and thus  $\{u, v, w_1, w_2, y\}$  induces  $H_4$  in  $G$ , leading to a contradiction. Therefore, we can assume, without loss of generality, that  $d_H^*(x) = d_H^*(y) = 2$  and  $d_H^*(u) = d_H^*(v) = 3$ . Again, there exists a vertex  $w_1 \in P$  such that  $u, v$  and  $w_1$  belong to a diamond  $D$  in  $G$ . Since  $G$  is  $\{H_3, H_4\}$ -free,  $N_G(w_1) \cap V(H) = \{u, v\}$ . Consequently, there exists a vertex  $w_2 \in D - H$  such that  $G[\{u, v, w_1, w_2\}] = D$  and  $N_G(w_2) \cap V(H) = \{u, v\}$ . Thus,  $\{u, v, w_1, w_2, y\}$  induces  $H_4$  in  $G$ , a contradiction again.

In what follows we can assume that  $G^*$  does not contain any induced diamond with at most two vertices in  $N$ .

*Case 2:  $G^*$  contains a diamond with exactly three non probe vertices.* Let  $u, v, w \in N$  be three vertices inducing a triangle in  $G^*$ . We are going to prove it implies that there exists an edge  $e = xy \in E(G)$  whose endpoints are complete to  $A = \{u, v, w\}$ . Since  $uv \in F$ , there exist two vertices  $x_1, y_1$  belonging to  $P$  such that  $\{u, v, x_1, y_1\}$  induces a diamond in  $G$  we call  $D_1$ . Consequently, it suffices to prove that  $w$  is adjacent to  $x_1$  and  $y_1$ . Suppose, by the way of contradiction, that  $w$  is adjacent to at most one of  $x_1$  and  $y_1$ . Suppose that  $w$  is adjacent to  $x_1$  and not adjacent to  $y_1$ . Therefore, there exists a vertex  $x_2 \in P$  not belonging to  $D_1$  and adjacent to  $u$  and  $w$ . Since there is no induced diamond in  $G^*$  with at most two nonprobe vertices,  $x_2$  is adjacent to  $x_1$ . Consequently,  $x_2$  is adjacent to  $v$  and thus  $x_2$  is adjacent to  $y_1$ . Therefore,  $\{v, w, y_1, x_2\}$  induces a diamond with exactly two nonprobe vertices, a contradiction. The contradiction arose by supposing that  $w$  is adjacent to  $x_1$  and not adjacent to  $y_1$ . Now, suppose that  $w$  is neither adjacent to  $x_1$  nor adjacent to  $y_1$ . Therefore, there exist two vertices  $x_2$  and  $y_2$  such that  $\{u, w, x_2, y_2\}$  induces a diamond  $D_2$  in  $G$ . By symmetry,  $v$  cannot have exactly one neighbor in  $\{x_2, y_2\}$ . Notice also that if  $v$  were complete to  $\{x_2, y_2\}$ , then we could choose  $e = x_2y_2$ . Let set  $B = \{x_1, y_1, v\}$ . If  $x_2$  ( $y_2$ ) is adjacent to at least one of the vertices belonging to  $B$ , since there is no diamond with exactly two nonprobe vertices, then  $x_2$  ( $y_2$ ) is complete to  $B$ . Therefore,  $\{v, w, y_1, x_2\}$  ( $\{v, w, y_1, y_2\}$ ) induces a diamond in  $G^*$  with exactly two nonprobe vertices, a contradiction. Consequently,  $x_2$  and  $y_2$  are anticomplete to  $B$ . Symmetrically, assuming that there is no edge in  $G$  complete to  $\{u, v, w\}$ , it can be proved that there exist two vertices  $x_3$  and  $y_3$  anticomplete to the triangles induced by  $\{x_i, y_i, u\}$  for  $i = 1, 2$  such that  $\{x_3, y_3, v, w\}$  induces a diamond  $D_3$  in  $G$ . Thus,  $D_1 \cup D_2 \cup D_3$  induces  $H_5$

in  $G$ , a contradiction again. So, there exists an edge  $xy \in E(G)$  complete to  $A$ . Finally, we will prove that if  $uv, vw, uw \in F$  there is no probe vertex  $z$  adjacent to  $u$  and  $v$  and not adjacent to  $w$ . Since  $\{u, v, w\}$  induces a triangle in  $G^*$  there exists an edge  $xy$  whose endpoints belong to  $P$  such that  $u, v$  and  $w$  are complete to  $xy$ . Suppose, by way of contradiction, that there exists a vertex  $z \in P$  such that  $z$  is adjacent to  $u$  and  $v$  and not adjacent to  $w$ . Since there is no induced diamond with exactly two nonprobe vertices in  $G^*$ ,  $z$  is adjacent to  $x$  and  $y$ . Consequently,  $\{x, y, v, z\}$  induces  $H_2$  in  $G$ , a contradiction.

*Case 3:  $G^*$  contains a diamond with four non probe vertices.* Finally, we will prove that there is no diamond in  $G^*$  with all its edges belonging to  $F$ . Suppose, by way of contradiction, that there exist four vertices  $u, v, w$  and  $z$  belonging to  $N$  and inducing a diamond in  $G^*$  such that  $d^*(w) = d^*(z) = 2$ ,  $\{u, v, w\}$  and  $\{u, v, z\}$  both induce a triangle in  $G^*$ . We know that there exist two adjacent vertices  $x$  and  $y$  belonging to  $P$  such that  $\{u, v, w\}$  is complete to  $\{x, y\}$  and two probe adjacent vertices  $r$  and  $s$  complete to  $\{u, v, z\}$ . Set  $e = xy$  and  $e' = rs$ . Notice that  $e \neq e'$ , because otherwise  $w$  would be adjacent to  $z$  in  $G^*$ . Indeed,  $\{x, y\} \cap \{r, s\} = \emptyset$ . First, suppose that  $r = x$ . If  $y$  were not adjacent to  $s$ ,  $\{x, y, v, s\}$  would induce  $H_3$ . Consequently, since  $G$  is  $H_3$ -free  $s$  is adjacent to  $y$ . Therefore,  $s$  is adjacent to  $w$  because, otherwise,  $\{x, y, s, w\}$  would induce  $H_2$ . So,  $\{x, s, w, z\}$  induces a diamond in  $G$  and thus  $w$  is adjacent to  $z$  in  $G^*$ , this is a contradiction that arises from supposing that  $r = x$ . Now, suppose that  $xy$  and  $rs$  are edges without endpoints in common. If  $\{x, y, w\}$  were anticomplete to  $\{r, s, z\}$ ,  $\{u, v, w, z, x, y, r, s\}$  would induce  $H_6$ . So, we can assume, without loss of generality, that  $r$  is either adjacent to  $x$  or adjacent to  $w$ . First, suppose that  $r$  is adjacent to  $x$ . Since there is no induced diamond with exactly two nonprobe vertices in  $G^*$ ,  $r$  is adjacent to  $w$ . We have proved that if  $r$  is adjacent to  $x$ , then  $r$  is adjacent to  $w$ . So, we can assume that  $w$  is adjacent to  $r$ . Therefore, since  $G^*$  does not contain any induced diamond with exactly two nonprobe vertices,  $s$  is adjacent to  $w$ . Consequently,  $\{s, r, y, w\}$  induces a diamond in  $G$  and thus  $w$  is adjacent to  $z$  in  $G^*$ , a contradiction.  $\square$

### Nonpartitioned probe diamond-free graphs

Let  $G$  and  $\mathcal{H}$  be a graph and a collection of graphs, respectively. We will say that  $F$  is a *subgraph of  $G$  with induced  $\mathcal{H}$*  if  $F$  is a subgraph of  $G$  and some  $H \in \mathcal{H}$  is an induced subgraph of  $F$ . Notice that in that case,  $H$  is also an induced subgraph of  $G$ . If  $\mathcal{H}$  is formed by only one graph  $H$ , we just say that  $F$  is a subgraph of  $G$  with induced  $H$ .

Before presenting the characterization by forbidden induced subgraphs for probe diamond-free graphs, we need to prove the following technical

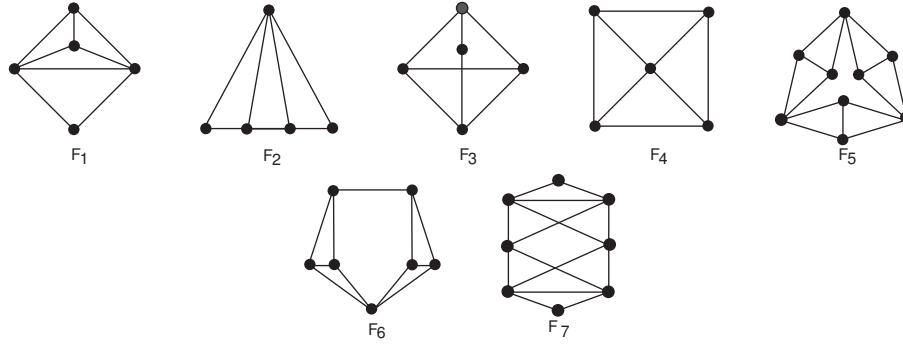

Figure 5.2: Some forbidden graph for probe diamond-free.

lemma.

**Lemma 21.** *Let  $G$  be a  $\{F_1, F_2, F_3, F_4\}$ -free graph. If  $G$  contains either  $S$  or  $T_1$  as a subgraph with induced diamonds, then  $G$  contains one of the graphs depicted in Figure 5.3 as induced subgraph.*

*Proof.* In what follows, we mean by “ $S$  ( $T_1$ ) is a subgraph of  $G$ ”,  $S$  ( $T_1$ ) is a subgraph of  $G$  with induced diamonds. Let  $G$  be a  $\{F_1, F_2, F_3, F_4\}$ -free graph. We will prove the lemma by contradiction. Suppose that  $G$  does not contain any graph depicted in Fig. 5.3 as induced subgraph. We are going to split the proof into two cases.

*Case 1:  $G$  contains a subgraph  $H$  isomorphic to  $S$ .* Suppose that the vertex set of the subgraph  $H$  is labeled by the set  $\{a, b, c, d, f, g\}$ . Assume, without loss of generality, that the set  $\{a, b, c, d\}$  induces one of the diamonds of  $H$  whose triangles are  $\{a, b, c\}$  and  $\{b, c, d\}$ ; and  $\{b, e, f, g\}$  induces the other diamond whose triangles are  $\{b, e, f\}$  and  $\{e, f, g\}$ . Since  $G$  contains  $S$  as subgraph but  $S$  is not an induced subgraph of  $G$ , there is at least one edge whose endpoints belong to  $\{a, b, c, d, f, g\}$  and are different from the edges belonging to the diamonds induced by  $\{a, b, c, d\}$  and  $\{b, e, f, g\}$ .

First, suppose that  $a$  is adjacent to  $e$ . So,  $a$  is either adjacent to  $f$  or adjacent to  $g$  because, otherwise,  $\{a, b, e, f, g\}$  would induce  $F_2$ . On the one hand, if  $a$  were adjacent to  $g$  and not adjacent to  $f$ ,  $\{a, b, e, f, g\}$  would induce  $F_4$ . On the other hand, if  $a$  were adjacent to  $g$  and not adjacent to  $f$ ,  $\{a, b, e, f, g\}$  would induce  $F_1$ . Consequently, since  $G$  is  $\{F_1, F_4\}$ -free,  $a$  is adjacent to  $f$  and  $g$ . By symmetry,  $e$  is adjacent to  $c$  and  $d$ . Therefore, if  $f$  were neither adjacent to  $c$  nor adjacent to  $d$ ,  $\{a, c, d, e, f\}$  would induce  $F_2$ . Hence, on the one hand,  $f$  is either adjacent to  $a$  or  $c$ . If  $f$  were adjacent to  $c$  and not adjacent to  $d$ ,  $\{a, c, d, e, f\}$  would induce  $F_1$ . On the other hand, if  $f$  were adjacent to  $d$  and not adjacent to  $c$ ,  $\{a, c, d, e, f\}$  would induce  $F_4$ . Consequently,  $f$  is adjacent to  $c$  and  $d$ . Therefore, if  $c$  were not adjacent to  $g$ ,  $\{b, c, e, f, g\}$  would induce  $F_1$ . Therefore,  $c$  is adjacent to  $g$ . So, if  $g$  were

not adjacent to  $d$ ,  $\{a, b, c, d, g\}$  would induce  $F_2$ . Therefore, since  $g$  is not adjacent to  $b$  and  $G$  is  $F_4$ -free,  $g$  is adjacent to  $d$ . Consequently,  $\{a, b, c, d, g\}$  induces  $F_4$ , a contradiction. This contradiction arose from supposing that  $a$  is adjacent to  $e$ . So, in what follows, we can assume that  $a$  is not adjacent to  $e$ . Symmetrically, we can also assume that  $a$  is not adjacent to  $f$  and  $d$  is not adjacent to  $f$ .

Suppose now that  $a$  is adjacent to  $g$ . Then, since  $a$  is not adjacent to  $e$  and  $f$ ,  $\{a, b, e, f, g\}$  induces  $F_3$ , a contradiction. This contradiction arose from supposing that  $a$  is adjacent to  $g$ . Therefore, we can assume that  $a$  is not adjacent to  $g$ . By symmetry, we can also assume that  $d$  is not adjacent to  $g$ . Suppose now that  $c$  is adjacent to  $g$ . Consequently,  $\{b, c, e, f, g\}$  induces  $F_3$ , a contradiction again. Therefore, we can also assume that  $c$  is not adjacent to  $g$ .

Now, suppose that  $c$  is adjacent to  $e$ . Hence,  $\{b, c, e, f, g\}$  induces  $F_2$ , a contradiction again. So, we can assume that  $c$  is not adjacent to  $e$ . By symmetry,  $c$  can be also assumed not to be adjacent to  $f$ . Therefore,  $V(H)$  induces a subgraph isomorphic to  $S$ , a contradiction.

In what follows, we can assume that  $G$  contains no subgraph isomorphic to  $S$ .

*Case 2:  $G$  contains a subgraph  $H$  isomorphic to  $T_1$  with induced diamonds.*

Suppose that the vertex set of the subgraph  $H$  is labeled by the set  $\{a, b, c, d, r, s, t, u\}$ . Assume, without loss of generality, that the set  $\{a, b, c, d\}$  induces one diamond in  $H$  with induced triangles  $\{a, b, c\}$  and  $\{b, c, d\}$  and  $\{r, s, t, u\}$  induces the other diamond with induced triangles  $\{r, s, t\}$  and  $\{s, t, u\}$ , and  $a$  is adjacent to  $r$ . Since  $G$  contains  $T_1$  as subgraph but  $T_1$  is not an induced subgraph of  $G$ , there is at least one edge whose endpoints belong to  $\{a, b, c, d, f, g\}$  different from the edges  $ar$  and the edges belonging to the diamonds induced by  $\{a, b, c, d\}$  and  $\{r, s, t, u\}$ , respectively.

First, suppose that  $a$  is adjacent to  $s$ . Notice that  $a$  is not adjacent to  $s$  because, otherwise,  $G[a, b, c, d, r, s, u]$  would contain a subgraph isomorphic  $F$  to  $S$  and thus  $F$  would be a subgraph of  $G$ . Consequently,  $\{a, r, s, t, u\}$  would induce a subgraph in  $G$  either isomorphic to  $F_1$  or isomorphic to  $F_2$ , a contradiction. Therefore, we can assume that  $a$  is not adjacent to  $s$ . By symmetry, we can also assume that  $a$  is not adjacent to  $t$  and  $r$  is not adjacent to  $b$  and  $c$ . Hence, if  $a$  were adjacent to  $u$ , then  $\{a, r, s, t, u\}$  would induce  $F_3$ . So, we can assume that  $a$  is not adjacent to  $u$ . By symmetry, we can also assume that  $r$  is not adjacent to  $d$ .

Suppose now that  $b$  is adjacent to  $s$ . Notice that, if  $b$  were adjacent to  $t$ ,  $\{a, b, r, s, t\}$  would induce  $F_3$ . So, we can assume that  $b$  is not adjacent to  $t$  and  $s$  is not adjacent to  $c$  (by symmetry). Therefore, if  $b$  were adjacent to  $u$ ,

then  $\{b, r, s, t, u\}$  would induce  $F_2$ , a contradiction. Hence, we can assume that  $b$  is not adjacent to  $u$  and, by symmetry,  $s$  is not adjacent to  $d$ . Suppose now that  $c$  is adjacent to  $t$ . Since  $G$  is  $T_5$ -free,  $d$  is adjacent to  $u$ . Therefore,  $\{a, b, c, d, r, s, t, u\}$  induces  $T_6$ , a contradiction. Therefore, we can assume that  $c$  is not adjacent to  $t$ . Suppose that  $d$  is adjacent to  $u$ . If  $c$  were adjacent to  $u$ , then  $\{b, c, d, u, s\}$  would induce  $F_3$ , a contradiction. Therefore, we can assume that  $c$  is not adjacent to  $u$ . By symmetry, we can also assume that  $t$  is not adjacent to  $d$ . Consequently,  $\{a, b, c, d, r, s, t, u\}$  induces  $T_{10}$ , a contradiction. The contradiction arose from supposing that  $d$  is adjacent to  $u$ . Therefore, we can assume that  $d$  is not adjacent to  $u$ . If  $c$  and  $t$  were adjacent to  $u$  and  $d$  respectively, then  $\{a, b, c, d, r, s, t, u\}$  would induce  $T_8$ . Therefore, we may assume that  $d$  is not adjacent to  $t$ . Therefore, on the one hand, if  $c$  were adjacent to  $u$ , then  $\{a, b, c, d, r, s, t, u\}$  would induce  $T_4$ . On the other hand, if  $c$  were not adjacent to  $u$ , then  $\{a, b, c, d, r, s, t, u\}$  would induce  $T_2$ . Both cases lead to a contradiction because  $G$  is  $\{T_4, T_8\}$ -free. This contradiction arose from supposing that  $b$  is adjacent to  $s$ . In what follows, we can assume that  $b$  is not adjacent to  $s$  and  $t$  and  $c$  is not adjacent to  $t$  and  $s$ .

Suppose that  $d$  is adjacent to  $u$ . Since  $G$  is  $T_7$ -free, either  $c$  is adjacent to  $u$ , or  $b$  is adjacent to  $u$ , or  $s$  is adjacent to  $d$ , or  $t$  is adjacent to  $d$ . Suppose, without loss of generality, that,  $u$  is either adjacent to  $b$  or adjacent to  $c$ . If  $c$  were adjacent to  $u$  and  $d$  were not adjacent to  $u$ ,  $\{a, b, c, d, u\}$  would induce  $F_2$ . Therefore, we can assume that  $c$  and  $b$  are adjacent to  $u$  and by symmetry  $s$  and  $t$  are not adjacent to  $d$ . Consequently,  $\{a, b, c, d, u\}$  induces  $F_1$ , a contradiction. So, in what follows, we can assume that  $d$  is not adjacent to  $u$ .

Suppose now that  $b$  is adjacent to  $u$ . If  $c$  were adjacent to  $u$ , since  $G$  is  $T_{11}$ -free,  $d$  would be either adjacent to  $s$  or adjacent to  $t$ . Suppose, without loss of generality, that  $d$  is adjacent to  $s$ . Consequently,  $\{b, c, d, u, s\}$  induces  $F_3$ , a contradiction. Therefore, we can assume that  $c$  is not adjacent to  $u$ . Suppose now that  $d$  is adjacent to  $s$ . If  $d$  were adjacent to  $t$ ,  $\{b, d, s, t, u\}$  would induce  $F_3$ . Therefore,  $d$  is not adjacent to  $t$  and thus  $\{a, b, c, d, r, s, t, u\}$  induces  $T_9$ , a contradiction. This contradiction arose from supposing that  $b$  is adjacent to  $u$ . Therefore, we can assume by symmetry that  $b$  and  $c$  are not adjacent to  $u$ ; and  $s$  and  $t$  are not adjacent to  $d$ . Finally,  $\{a, b, c, d, r, s, t, u\}$  induces  $T_1$ , a contradiction. □

**Theorem 47.** *Let  $G$  be a graph.  $G$  is probe diamond-free if and only if  $G$  does not contain any graph depicted in Figures 5.2 and 5.3 as induced subgraph.*

*Proof.* Let  $G$  be a graph not containing any graph depicted in Figures 5.2 and 5.3 as induced subgraph. Let  $N$  be the set of vertices of  $G$  belonging to

---

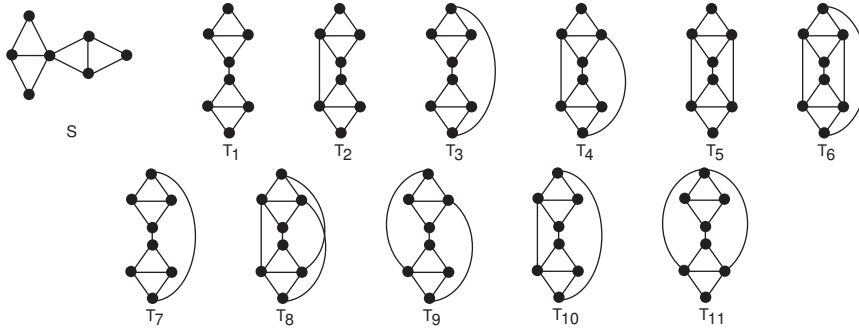

Figure 5.3: Some forbidden subgraphs for probe diamond-free graphs.

a tip of an induced diamond and  $P = V \setminus N$ . Let  $F$  be a set of non-edges of  $G$  whose endpoints are tips of the same diamond.

First, we are going to prove that  $N$  is a stable set of  $G$ . Suppose, by the way of contradiction, that there exist two adjacent vertices  $u$  and  $a$  belonging to  $N$ . Suppose that  $u$  belongs to a diamond  $D_1$  induced by the vertices  $\{u, v, w, x\}$  whose other tip is  $x$  and  $a$  belongs to another diamond  $D_2$  induced by  $\{a, b, c, d\}$  whose other tip is  $d$ . Suppose that  $u$  is adjacent to  $a$ . If  $V(D_1)$  did not meet  $V(D_2)$ , then  $D_1 \cup D_2$  would induce a subgraph in  $G$  that contains  $T_1$  as subgraph. By Lemma 21, since  $G$  does not contain  $F_i$  for  $i = 1, \dots, 4$  as induced subgraph,  $G$  contains one of the graphs depicted in Figure 5.3 as induced subgraph, a contradiction. Hence, we can assume that the diamonds  $D_1$  and  $D_2$  have at least one vertex in common. First, suppose that  $d = x$  and  $\{v, w\} \cap \{b, c\} = \emptyset$ . Since  $G$  is  $F_6$ -free, there exists at least one edge different from  $au$  such that one of its endpoints belong to  $\{u, v, w, x\}$  and the other one belongs to  $\{a, b, c, d\}$ . Suppose that  $w$  is adjacent to  $a$ . Since  $G$  is  $F_2$ -free,  $v$  is adjacent to  $a$ . Consequently,  $\{a, d, u, v, w\}$  induces  $F_1$ , a contradiction. Therefore, we can assume that  $a$  is not adjacent to  $w$ . By symmetry, we can also assume that  $v$  is not adjacent to  $a$  and  $u$  is not adjacent to  $b$  and  $c$ . Suppose now that  $w$  is adjacent to  $b$ . Since  $G$  is  $F_2$ -free and  $w$  is not adjacent to  $a$ ,  $w$  is adjacent to  $c$ . So,  $\{a, b, c, d, w\}$  induces  $F_1$ , a contradiction. Therefore,  $w$  is not adjacent to  $b$ . Symmetrically,  $w$  is not adjacent to  $c$  and  $v$  is not adjacent to  $b$  and not adjacent to  $c$ . This leads to a contradiction because  $G$  is  $F_6$ -free. Hence, we can assume that  $D_1$  and  $D_2$  have at least two vertices in common.

Suppose that  $x = d$  and  $b = w$ . Notice that  $v$  is not adjacent to  $a$  and  $c$  is not adjacent to  $u$  because, otherwise,  $\{a, b, d, u, v\}$  and  $\{a, b, c, d, u\}$  would induce  $F_1$ , respectively. Therefore, since  $G$  is  $F_2$ -free,  $v$  is adjacent to  $c$ . Consequently,  $\{a, b, c, u, v\}$  induces  $F_4$ , a contradiction. Hence, we can assume that  $D_1$  and  $D_2$  have exactly three vertices in common. We can assume, without loss of generality, that  $x = d$ ,  $w = b$  and  $v = c$ .

Consequently,  $\{a, b, c, d, u\}$  induces  $F_1$ , a contradiction.

Finally, in order to prove that  $N$  is a stable set, it suffices to prove that  $a$  is different from  $w$ . Suppose, by the way of contradiction, that  $a = w$ . If  $v$  and  $x$  were different from  $b, c$  and  $d$ , then  $G$  would contain  $S$  as subgraph. By Lemma 21,  $G$  would contain one of the graphs depicted in Figure 5.3 as induced subgraph, a contradiction. Suppose now that  $u = b$ . Since  $G$  is  $\{F_1, F_2\}$ -free,  $d$  is adjacent to  $v$  and  $x$ . So, if  $x$  were not adjacent to  $c$ , then  $\{a, b, c, d, x\}$  would induce  $F_3$ . Consequently,  $x$  is adjacent to  $c$  and thus  $\{a, b, c, d, c, x\}$  induces  $F_4$ , a contradiction. Therefore, we can assume that  $d = v$ . Since  $G$  is  $F_2$ -free,  $c$  is adjacent to  $x$ . Consequently,  $\{a, b, c, d, x\}$  induces  $F_4$ , a contradiction. Finally, we have proved that the set  $N$  is a stable set.

It remains to prove that the completion  $G^* = (V, E \cup F)$  is diamond-free. By Theorem 46, it suffices to prove that the partitioned graph  $G = (N \cup P, E)$  with probe partition  $(N, P)$  does not contain any of the partitioned graphs depicted in Figure 5.2.1. By the construction of the partition  $(N, P)$ ,  $G = (N \cup P, E)$  does not contain  $H_1, H_2$  and  $H_3$ . Finally, since  $G$  is  $\{F_3, F_5, F_7\}$ -free, the partitioned graph  $G = (N \cup P, E)$  does not contain the partitioned subgraphs  $H_4, H_5$  and  $H_6$ . □

## 5.2.2 Probe block graphs

In this section the characterization for probe diamond-free graphs is used to characterize probe block graphs. Notice that if every component of a graph is probe block then the graph is probe block. Indeed, suppose that  $\{C_i\}_{1 \leq i \leq k}$  are the components of a graph  $G = (V, E)$  and  $G[C_i]$  are probe block with probe block partitions  $(P_i, N_i)$  and completions  $G_i^* = (N_i \cup P_i, E(C_i) \cup F_i)$  for  $i = 1, \dots, k$ . Let  $v_i \in N_i$  (if  $N_i = \emptyset$ ,  $v_i$  is chosen arbitrarily among the vertices of  $C_i$ ). Then, we can construct a probe block completion  $G^* = (N \cup P, E \cup F)$  with  $N$  formed by all the vertices belonging to some  $N_i$  and the ones chosen arbitrary when  $N_i = \emptyset$ ; and  $F$  formed by those edges belonging to some  $F_i$  and  $v_i v_{i+1}$  for  $i = 1, \dots, k-1$ . Consequently, we can restrict our analysis to connected graphs.

The following two lemmas are preliminary results to prove the main characterization of this section.

**Lemma 22.** [GL04] *Let  $G$  be a probe chordal graph. Then,  $G$  has no induced  $C_{2k+1}$  for  $k \geq 2$ .*

**Lemma 23.** [GL04] *Let  $G$  be a probe chordal graph. Then, for any partition into probe and nonprobe vertices, probe and nonprobe vertices alternate for any chordless cycle in  $G$ .*

---



By combining the two above Lemmas, we can obtain the following result.

**Theorem 48.** *Let  $G$  be a connected probe block graph. Then,  $G$  is chordal.*

*Proof.* Let  $G = (V, E)$  be a probe block graph. Since block graphs are chordal,  $G$  is probe chordal. Consequently, by Lemma 22,  $G$  has no  $C_{2k+1}$  for  $k \geq 2$  as induced subgraph. Suppose, by the way of contradiction, that  $G$  contains an even induced cycle  $H = v_1v_2 \cdots v_{2k}v_1$  for some  $k \geq 2$ . By Lemma 23, for any probe block partition of  $G$  into probe ( $P$ ) and nonprobe ( $N$ ) vertices, vertices belonging to  $P$  and  $N$  alternate in  $H$ . In what follows, sums should be considered modulo  $2k$ . Suppose, without loss of generality, that  $v_{2i-1} \in P$  for  $i = 1, \dots, k$  and  $v_{2i} \in N$  for  $i = 1, \dots, k$ . Notice that, if  $G^* = (V, E \cup F)$  is a completion of  $G$  such that  $G^*$  is a block graph, since  $G^*$  is chordal,  $v_{2i-1}v_{2i+1} \in F$  for  $i = 1, \dots, k$ . Otherwise,  $G^*$  would contain a chordless cycle greater than 4. Consequently, if  $k = 2, 3$  it is easy to see that  $G^*$  contains a diamond, a contradiction. Therefore, we can assume that  $k \geq 4$ . Since  $G^*$  is chordal,  $v_{2i}v_{2i+2} \in F$  for  $i = 1, \dots, k$ . In addition, if  $v_2v_6$  did not belong to  $F$ ,  $\{v_2, v_4, v_6\}$  would be contained in an induced cycle of  $G^*$  of length at least 4. Consequently,  $\{v_2, v_3, v_4, v_6\}$  induces a diamond in  $G^*$ , a contradiction.  $\square$

We have already proved that the class of probe block graphs is probe diamond-free and chordal. The following Lemma proves that the graph obtained by adding all the edges to a chordal probe diamond-free graph whose endpoints are tips of a diamond remains chordal. Consequently, every graph chordal and probe diamond-free is probe block.

**Lemma 24.** *Let  $G = (V, E)$  be a connected probe block graph and  $F$  be the set of edges of  $\overline{G}$  whose endpoints are tips of some diamond in  $G$ . Then,  $G^* = (V, E \cup F)$  is chordal.*

*Proof.* Throughout the proof, sums should be considered modulo  $k$ . Let  $F$  be the subset of edges of  $G^*$  defined as in the lemma. Suppose, by way of contradiction, that  $G^* = (V, E \cup F)$  contains an induced cycle  $H = v_1, \dots, v_kv_1$  for  $k \geq 4$  as induced subgraph. By Theorem 48,  $v_i v_{i+1} \in F$  for some  $i = 1, \dots, k$ . Assume that the cycle contains the minimum number of nonprobe vertices among all the induced cycles contained in  $G^*$ . By construction, there exists a vertex  $w_1 \in P$  adjacent to  $v_i$  and  $v_{i+1}$ . By minimality on the number of nonprobe vertices of  $H$  and since  $G^*$  is diamond free,  $w_1$  is anticomplete to  $V(H) - \{v_i, v_{i+1}\}$  in  $G^*$ . If  $E(H) \cap F = v_i v_{i+1}$ , then  $G[V(H) \cup \{w_1\}]$  would induce a cycle in  $G$ , a contradiction. Thus, we can assume that there exists an edge  $v_j v_{j+1} \in F$  with  $i \neq j$  such that  $v_j v_{j+1} \in F$ . Therefore, there exists a vertex  $w_2 \neq w_1$  belonging to  $P$  and adjacent to  $v_j$  and  $v_{j+1}$  which is also anticomplete to  $E(H) - \{v_j v_{j+1}\}$ . In addition, by the minimality on the number of nonprobe vertices in  $H$ , it

follows that  $w_1w_2 \notin E(G)$ . Again, if there were no other edges belonging to  $H$  in  $F$ ,  $G$  would contain an induced cycle greater than 4, a contradiction. Repeating this procedure, if were necessary, for any edge of  $H$  belonging to  $F$ , we conclude that  $G$  is not chordal, a contradiction again.  $\square$

By combining Theorem 47, Lemma 48 and Lemma 24, it follows the characterization for probe block graphs. This characterization pointed out the relationship between the class of probe block graphs and Ptolemaic graphs. Indeed, the below theorem shows that probe block graphs are a subclass of Ptolemaic graphs.

**Theorem 49.** *Let  $G$  be a connected graph. The following statements are equivalent:*

1.  $G$  is a probe block graph.
2.  $G$  is chordal and probe diamond-free.
3.  $G$  is Ptolemaic and  $\{F_1, S, T_1\}$ -free.

*Proof.* 1.  $\Rightarrow$  2. On the one hand, since block graphs are chordal and diamond-free, the class of probe block graphs is contained in the class of probe diamond-free graphs. On the other hand, by Theorem 48, it follows that the class of probe block graphs is contained in the class of probe chordal graphs.

2.  $\Rightarrow$  3. Let  $G$  be a probe diamond-free and chordal graph. By Theorem 47,  $G$  is  $F_2$  free. Consequently, since  $G$  is chordal,  $G$  is Ptolemaic. In addition, all the graphs depicted in Figures 5.2 and 5.3 are chordal but  $F_1$ ,  $F_2$ ,  $S$  and  $T_1$ . Therefore,  $G$  is Ptolemaic and  $\{F_1, S, T_1\}$ -free.

3.  $\Rightarrow$  2. Straightforward.  $\square$

## Chapter 6

# Conclusions and future work

In this Thesis we study structural characterizations for circular-arc graphs, circle graphs, probe interval graphs, probe unit interval graphs, probe co-bipartite graphs, and probe block graphs. We partially characterize circular-arc graphs, circle graphs, probe interval graphs and probe unit interval graphs by forbidden induced subgraphs within certain hereditary families of graphs. Finally, a structural characterization for probe co-bipartite graphs that leads to a polynomial-time recognition algorithm and a complete characterization of probe block graphs by a list of forbidden induced subgraphs are presented.

In Chapter 2 circular-arc graphs are characterized within cographs (Theorem 16), paw-free graphs (Theorem 19) and claw-free chordal graphs (Theorem 21). Some open questions for circular-arc graphs from a structural point of view are the following.

**Question 1.** *Give a forbidden induced subgraph characterization for circular-arc graphs within the class of chordal graphs.*

**Question 2.** *Give a forbidden induced subgraph characterization for circular-arc graphs within the class of  $K_4$ -free graphs.*

**Question 3.** *Characterize circular-arc graphs within the class of claw-free graphs. A good start point could be to characterize circular-arc graphs within the class of graphs with stability number at most two.*

**Question 4.** *Find a characterization by forbidden induced subgraphs for normal circular-arc graphs.*

**Question 5.** *Find a characterization by forbidden induced subgraphs for Helly circular-arc graphs.*

In Chapter 3, circle graphs are characterized within the classes of linear domino graphs (Theorem 28),  $P_4$ -tidy graphs (Theorem 30) and tree-cographs (Theorem 31). Finally, the class of Helly unit circle graphs is in-

troduced and completely characterized (Theorem 32). Next, we will present some open questions for the class of circle graphs.

**Question 6.** *Characterize the whole class of circle graphs by forbidden induced subgraphs.*

**Question 7.** *Find a decomposition such that Helly circle graphs are closed under this decomposition (analogous to the split decomposition for circle graphs).*

**Question 8.** *Characterize Helly circle graphs by forbidden induced subgraphs.*

In Chapter 4, we provide forbidden induced subgraphs characterizations for probe interval graphs (resp. probe unit interval graphs) within two superclasses of cographs, namely tree-cographs (Theorem 38) (resp. Theorem 43) and  $P_4$ -tidy graphs (Theorem 39) (resp. Theorem 44). We would like to mention some open questions.

**Question 9.** *Characterize probe unit interval graphs by forbidden induced subgraphs within the class of probe interval graphs.*

**Question 10.** *Characterize the whole class of probe interval graphs and probe unit interval graphs by forbidden induced subgraphs.*

**Question 11.** *Characterize probe circular arc-graphs by forbidden induced subgraphs within the class of trees.*

In Chapter 5, we present a structural characterization for probe co-bipartite graphs (Theorem 45) that leads to a polynomial-time recognition algorithm for this class and a characterization by forbidden subgraphs for the class of probe block graphs (Theorem 49). Some open problems in connection with this topic are the following.

**Question 12.** *Characterize by forbidden induced subgraph the class of probe chordal graphs.*

**Question 13.** *Decide whether a given graph is probe line graph.*

---

# Bibliography

- [ACH<sup>+</sup>07] L. Alcón, M.R. Cerioli, C.M. Herrera de Figueiredo, M. Gutierrez, and J. Meidanis, *Tree loop graphs*, Discrete Mathematics **155** (2007), no. 6–7, 686–694.
- [BBd09] D. Bayer, V. Bang Le, and H. N. de Ridder, *Probe threshold and probe trivially perfect graphs*, Theoretical Computer Science **410** (2009), no. 47–49, 4812–4822.
- [BDd<sup>+</sup>] F. Bonomo, G. Durán, C. H. de Figueiredo, L.N. Grippo, M.D. Safe, J. Swarcfiter, and R. Texeira, *Two remarks on probe classes of graphs*, in preparation.
- [BDGS] F. Bonomo, G. Durán, L.N. Grippo, and M.D. Safe, *Partial characterizations of circle graphs*, Discrete Applied Mathematics, in press.
- [BDGS09] ———, *Partial characterizations of circular-arc graphs*, Journal of Graph Theory **61** (2009), no. 4, 289–306.
- [BH94] J. Bang-Jensen and P. Hell, *On chordal proper circular arc graphs*, Discrete Mathematics **128** (1994), 395–398.
- [BL06] D. E. Brown and J. R. Ludgren, *Bipartite probe interval graphs, circular-arc graphs, and interval point bigraphs*, Australasian Journal of Combinatorics **35** (2006), 221–236.
- [BLS09] D. E. Brown, J. R. Ludgren, and L. Sheng, *Characterization of cycle-free unit probe interval graphs*, Discrete Applied Mathematics **157** (2009), 762–767.
- [Bou87] A. Bouchet, *Reducing prime graphs and recognizing circle graphs*, Combinatorica **7** (1987), 243–254.
- [Bou94] ———, *Circle graph obstructions*, Journal of Combinatorial Theory. Series B **60** (1994), 107–144.
- [CCK<sup>+</sup>08] D.B. Chandler, M.-S. Chang, T. Kloks, V. Bang Le, and S.-L. Peng, *Probe Ptolemaic graphs*, COCOON, 2008, pp. 468–477.
- [CCK<sup>+</sup>09] D.B. Chandler, D.-M. Chang, T. Kloks, J. Liu, and S.-L. Peng, *On probe permutation graphs*, Discrete Applied Mathematics **157** (2009), 2611–2619.
- [CDG02] H. Czemerinski, G. Durán, and A. Gravano, *Bouchet Graphs: A Generalization of Circle Graphs*, Congressus Numerantium **155** (2002), 95–108.
- [CGLS10] E. Cohen, M.C. Golumbic, M. Lipshteyn, and M. Stern, *On the bi-enhancement of chordal-bipartite probe graphs*, Information Processing Letters **110** (2010), no. 5, 193–197.
- [CH75] V. Chvátal and P. L. Hammer, *Aggregation of inequalities in integer programming*, Tech. report, Stanford University, Stanford, CA, USA, 1975.
- [CK08] M. Chudnovsky and R. Kapadia, *Detecting a theta or a prism*, SIAM Journal on Discrete Mathematics **22** (2008), no. 3, 1164–1186.

- [CLS81] D. G. Corneil, H. Lerchs, and L. Stewart Burlingham, *Complement reducible graphs*, Discrete Applied Mathematics **3** (1981), no. 3, 163–174.
- [CO00] B. Courcelle and S. Olariu, *Upper bounds to the clique width of graphs*, Discrete Applied Mathematics **101** (2000), no. 1-3, 77–114.
- [Con89] M. Conforti,  *$(K_4 - e)$ -free graphs and star cutsets*, Lecture Notes in Mathematics **1403** (1989), 236–253.
- [CPS84] D. Corneil, Y. Perl, and L. Stewart, *Cographs: recognition, applications and algorithms*, Congressus Numerantium **43** (1984), 249–258.
- [CS05] M. Chudnovsky and P. D. Seymour, *The structure of claw-free graphs*, London Mathematical Society Lecture Note Series **327** (2005), 153–171.
- [Cun82] W. H. Cunningham, *Decomposition of directed graphs*, SIAM Journal on Algebraic and Discrete Methods **3** (1982), 214–228.
- [CY81] L. Chong-Keang and P. Yee-Hock, *On graphs without multicliqual edges*, Journal of Graph Theory **5** (1981), 443–451.
- [DGM<sup>+</sup>06] G. Durán, A. Gravano, R. M. McConnell, J. Spinrad, and A. Tucker, *Polynomial time recognition of unit circular-arc graphs*, Journal of Algorithms **58** (2006), 67–78.
- [DGR10] J. Daligault, D. Gonçalves, and M. Rao, *Diamond-free circle graphs are Helly circle*, Discrete Mathematics **310** (2010), no. 4, 845–849.
- [DGS] G. Durán, L. N. Grippo, and M. D. Safe, *Probe interval graphs and probe unit interval graphs on superclasses of cographs*, Electronic Notes in Discrete Mathematics, to appear.
- [DHH96] X. Deng, P. Hell, and J. Huang, *Linear time representation algorithms for proper circular-arc graphs and proper interval graphs*, SIAM Journal on Computing **25** (1996), 390–403.
- [Dur00] G. Durán, *Sobre grafos intersección de arcos y cuerdas en un círculo*, Ph.D. thesis, Departamento de Computación, FCEyN, Universidad de Buenos Aires, Buenos Aires, 2000.
- [Dur03] ———, *Some new results on circle graphs*, Matemática Contemporânea **25** (2003), 91–106.
- [EI71] S. Even and A. Itai, *Queues, stacks and graphs*, Theory of Machines and Computations (A. Kohavi and A. Paz, eds.), Academic Press, New York, 1971, pp. 71–86.
- [Gal67] T. Gallai, *Transitiv orientierbare Graphen*, Acta Mathematica Academiae Scientiarum Hungaricae **18** (1967), no. 1–2, 25–66.
- [Gas97] E. Gasse, *A proof of a circle graph characterization*, Discrete Mathematics **173** (1997), no. 1–3, 277–283.
- [Gav74] F. Gavril, *The intersection graphs of subtrees in trees are exactly the chordal graphs*, Journal of Combinatorial Theory. Series B **16** (1974), 47–56.
- [GJMP80] M. Garey, D. Johnson, G. Miller, and C. Papadimitriou, *The complexity of coloring circular arcs and chords*, SIAM Journal on Algebraic and Discrete Methods **1** (1980), 216–227.
- [GL04] M. C. Golumbic and M. Lipshteyn, *Chordal probe graphs*, Discrete Applied Mathematics **143** (2004), no. 1-3, 221–237.
- [GO09] J. Geelen and S.-L. Oum, *Circle graph obstructions under pivoting*, Journal of Graph Theory **61** (2009), no. 1, 1–11.
- [Gol04] M. C. Golumbic, *Algorithmic Graph Theory and Perfect Graphs*, second ed., Annals of Discrete Mathematics, vol. 57, North-Holland, Amsterdam, 2004.
-

- 
- [GRT97] V. Giakoumakis, F. Roussel, and H. Thuillier, *On  $P_4$ -tidy graphs*, Discrete Mathematics & Theoretical Computer Science **1** (1997), no. 1, 17–41.
- [HDK64] H. Hadwiger, H. Debrunner, and V. Kee, *Combinatorial Geometry in the Plane*, Holt Rinehart and Winston, New York, 1964.
- [HF77] P. Hammer and S. Földes, *Split graphs having Dilworth number two*, Canadian Journal of Mathematics **29** (1977), 666–672.
- [HH04] P. Hell and J. Huang, *Interval bigraphs and circular arc graphs*, Journal of Graph Theory **46** (2004), 313–327.
- [Hoà85] C.T. Hoàng, *Perfect graphs*, Ph.D. thesis, School of Computer Science, McGill University, Montreal, 1985.
- [How81] E. Howorka, *A characterization of ptolemaic graphs*, Journal of Graph Theory **5** (1981), 323–331.
- [JO89] B. Jamison and S. Olariu, *A new class of brittle graphs*, Studies in Applied Mathematics **1203** (1989), 89–92.
- [JO91] ———, *On a unique tree representation for  $P_4$ -extendible graphs*, Discrete Applied Mathematics **34** (1991), 151–164.
- [KKM95] T. Kloks, D. Kratsch, and H. Müller, *Dominoes*, Lecture Notes in Computer Science **903** (1995), 106–120.
- [Kle69] V. Klee, *What are the intersection graphs of arcs in a circle?*, The American Mathematical Monthly **76** (1969), 810–813.
- [LB62] C. Lekkerkerker and D. Boland, *Representation of finite graphs by a set of intervals on the real line*, Fundamenta Mathematicae **51** (1962), 45–64.
- [LdR07] V. Le and H. de Ridder, *Probe split graphs*, Discrete Mathematics & Theoretical Computer Science **9** (2007), 207–238.
- [LLMT09] B. Lévêque, D. Y. Lin, F. Maffray, and N. Trotignon, *Detecting induced subgraphs*, Discrete Applied Mathematics **157** (2009), no. 17, 3540–3551.
- [LS06a] M. C. Lin and J. L. Szwarcfiter, *Characterizations and linear time recognition of Helly circular-arc graphs*, Lecture Notes in Computer Science **4112** (2006), 73–82.
- [LS06b] ———, *Efficient construction of unit circular-arc models*, Proceedings of the 17th Annual ACM-SIAM Symposium on Discrete Algorithms, 2006, pp. 309–315.
- [LSS07] M.C. Lin, F.J. Soulignac, and J.L. Szwarcfiter, *Proper Helly circular-arc graphs*, Lecture Notes in Computer Science **4769** (2007), 248–257.
- [LZ94] J. Liu and H. Zhou, *Dominating subgraphs in graphs with some forbidden structures*, Discrete Mathematics **135** (1994), 163–168.
- [McC03] R. M. McConnell, *Linear-time recognition of circular-arc graphs*, Algorithmica **37** (2003), no. 2, 93–147.
- [Naj85] W. Naji, *Reconnaissance des graphes de cordes*, Discrete Mathematics **54** (1985), no. 3, 329–337.
- [Ola88] S. Olariu, *Paw-free graphs*, Information Processing Letters **28** (1988), no. 1, 53–54.
- [PC05] N. Pržulj and D. Corneil, *2-tree probe interval graphs have a large obstruction set*, Discrete Applied Mathematics **150** (2005), 216–231.
- [PLE71] A. Pnueli, A. Lempel, and S. Even, *Transitive orientation of graphs and identification of permutation graphs*, Canadian Journal of Mathematics **23** (1971), 160–175.
-

- [PR76] K. Parthasarathy and G. Ravindra, *The strong perfect-graph conjecture is true for  $K_{1,3}$ -free graphs*, Journal of Combinatorial Theory. Series B **21** (1976), no. 3, 212–223.
- [Rob69] F.S. Roberts, *Indifference graphs*, Proof Techniques in Graph Theory (F. Harary, ed.), Academic Press, 1969, pp. 139–146.
- [Sei74] D. Seinsche, *On a property of the class of  $n$ -colorable graphs*, Journal of Combinatorial Theory. Series B **16** (1974), 191–193.
- [She99] L. Sheng, *Cycle-free probe interval graphs*, Congressus Numerantium **140** (1999), 33–42.
- [SHKP09] M-S. Shang, L-J. Hung, T. Kloks, and S-L. Peng, *Block-graph width*, Lecture Notes in Computer Science **5532** (2009), 150–157.
- [Spi94] J. Spinrad, *Recognition of circle graphs*, Journal of Algorithms **16** (1994), no. 2, 264–282.
- [Tin89] G. Tinhofer, *Strong tree-cographs are Birkhoff graphs*, Discrete Applied Mathematics **22** (1989), no. 3, 275–288.
- [TM76] W. T. Trotter and J. I. Moore, *Characterization problems for graphs, partially ordered sets, lattices, and families of sets*, Discrete Mathematics **16** (1976), no. 4, 361–381.
- [Tuc60] A. Tucker, *Two characterizations of proper circular-arc graphs*, Ph.D. thesis, Stanford University, Stanford Operation Research Department, Stanford, Calif. USA, 1960.
- [Tuc74] ———, *Structure theorems for some circular-arc graphs*, Discrete Mathematics **7** (1974), 167–195.
- [Tuc87] ———, *Coloring perfect  $(K_4 - e)$ -free graphs*, Journal of Combinatorial Theory. Series B **42** (1987), 313–318.
- [Weg67] G. Wegner, *Eigenshofte der nerven homologisch-einfacher familien in  $\mathbb{R}^n$* , Ph.D. thesis, Göttingen, 1967.
- [ZSF<sup>+</sup>94] P. Zhang, P. Schon, E.A. Fischer, E. Gayanis, J. Weiss, S. Wistler, and P.E. Bourne, *An algorithm based on graph theory for the assembly of contigs in physical mapping of DNA*, Computer applications in the biosciences : CABIOS **10** (1994), no. 3, 309–317.
-



# Index

- 2-connected, 3
- $G - v$ , 2
- $G[\pi]$ , 5
- $K_n$ , 2
- $T(G)$ , 59
- $\mathcal{H}$ -free, 2
- $tG$ , 12
  
- anticomplete, 1
- anticomponent, 3
- anticonnected, 3
- asteroidal triple, 4
- augmented, 12
  
- bipartite graph, 2
- block graph, 3
- block graphs, 7
- bloomed, 12
- blooms, 12
  
- chord, 3
- chordal graphs, 6
- chordless cycle, 2
- chordless path, 2
- circle graph, 29
- circle model, 29
- circular-arc graphs, 11
- circular-arc model, 11
- clique, 2
- close neighborhood, 1
- cograph, 8
- comparability graph, 5
- complement graph, 1
- complete, 1
- complete bipartite, 2
- complete set, 2
- completion, 41
  
- component, 3
- connected, 3
- cut vertex, 3
- cycle, 2
  
- degree, 1
- diamond, 2
- digraph, 1
- disjoin union, 2
- dominating set, 43
- domino graph, 3
  
- edge, 1
- edge subdivision, 3
- empty graph, 1
- endpoints, 1
  
- false twins, 1
- fully bloomed, 12
  
- graph, 1, 2
  
- hole, 3
  
- induced cycle, 2
- induced partitioned subgraph, 60
- induced path, 2
- induced subgraph, 1
- internal vertices, 2
- interval graphs, 4
- interval model, 4
- isolated vertex, 1
- isomorph, 1
  
- linear domino graph, 3
- local complement, 30
- local complementation, 30
- locally equivalent, 30

marker vertices, 31  
minimally non-*mathcal{G}*, 2  
multiple, 12

neighborhood, 1  
non- $\mathcal{G}$ , 2  
nonedge, 1  
nonprobe vertices, 42

orientation, 5

partitioned graph, 60  
partitioned probe  $\mathcal{G}$ , 60  
partitioned subgraph, 60  
partner, 8  
path, 2  
paw, 2  
permutation graph, 6  
prism, 3  
probe  $\mathcal{G}$ , 42  
probe  $\mathcal{G}$  partition, 42  
probe co-bipartite, 59  
probe complete, 7  
probe vertices, 42  
proper interval graphs, 4  
ptolemaic raphs, 8

semicircular graphs, 15  
split complete graphs, 7  
split decomposition, 31  
split graphs, 7  
stable set, 2  
subgraph, 1

tips, 61  
transitive orientation, 5  
triangle, 2  
trivial bloom, 12  
true twins, 1

unit interval graphs, 4  
universal vertex, 1

vertex, 1

---